

SERVICEKARTE /SERVICECARD

Modellname/Modelname:
BETT/BED 0873

Ausführung/Finishing:
Wildeiche massiv geölt, polsterkopfteil anthrazit
Oak massive oiled, upholstered anthracite

140x200

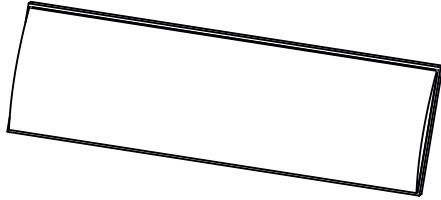

160x200

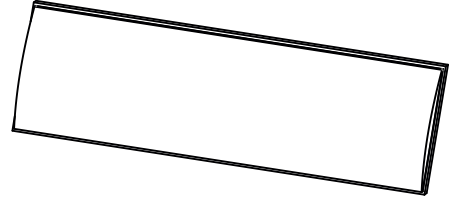

1016973

1016974

180x200

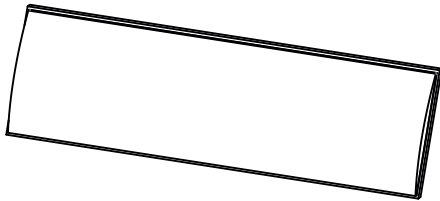

200x200

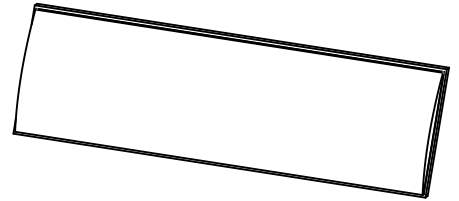

1016975





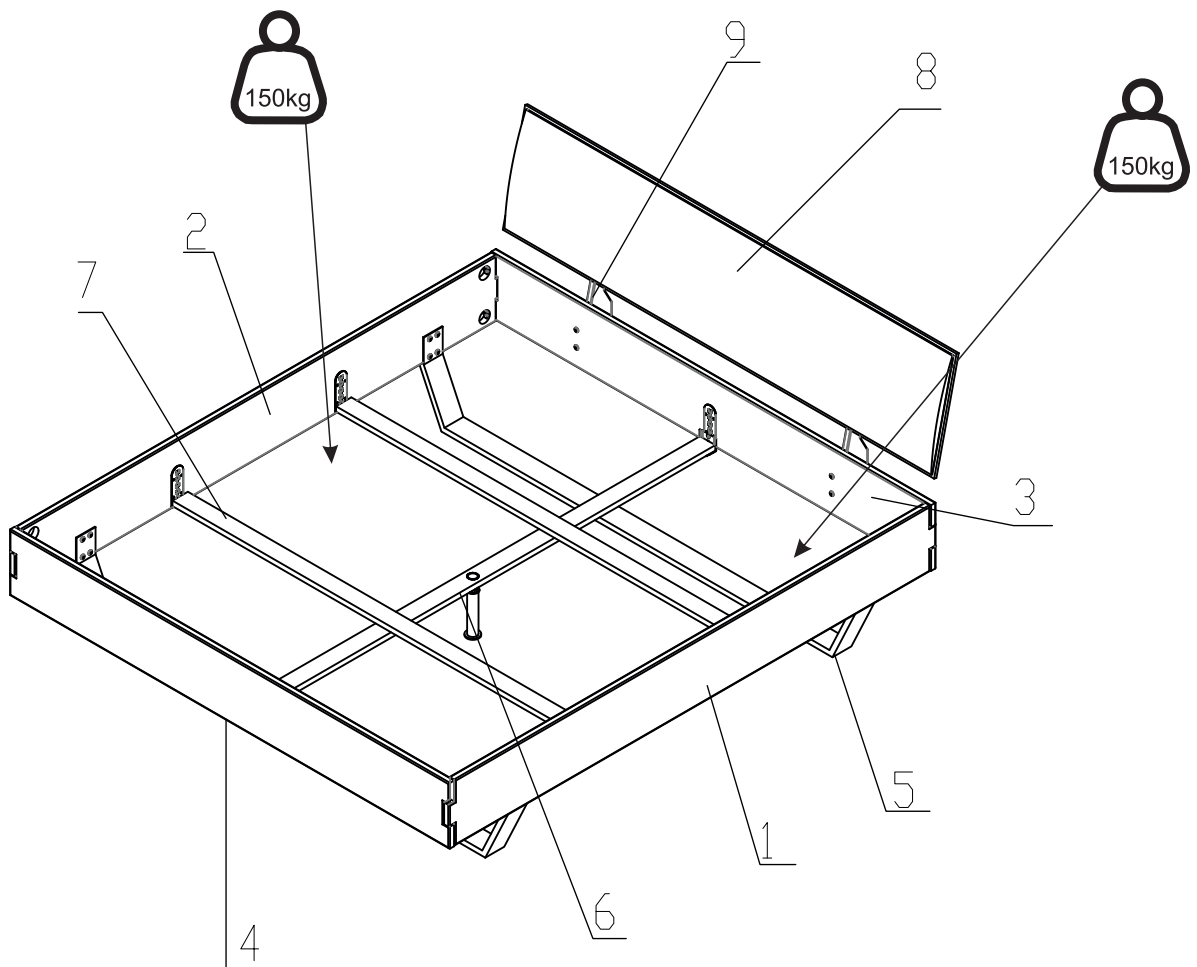







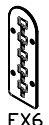

1016981

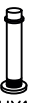
71306













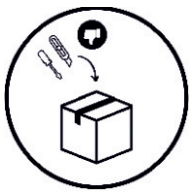

DE: Sehr geehrter Kunde, Sehr geehrte Kundin!
 Fehlt Ihnen ein Beschlagteil oder ist es defekt? Kein Problem! Nutzen Sie unsere Servicekarte!
 Unser Direkt-Bestellservice für fehlende/defekte Beschlagteile:
 Kontaktieren Sie uns telefonisch unter Tel. +499503/5033-114 oder senden Sie uns eine E-Mail an kundendienst@3s-frankenmoebel.de.
 Bitte geben Sie dabei folgende Pflicht-Informationen an: -> Auftragsnummer, Artikelnummer, Nummer des Beschlagteils,
 fehlende/defekte Menge, und den Grund der Beanstandung, ob es sich um ein defektes oder fehlendes Beschlagteil handelt. Tragen Sie
 die benötigte Menge ein. Mailen Sie uns die vollständig ausgefüllte Servicekarte zu, um die Bearbeitung zu ermöglichen. Für andere
 Beanstandungen / Beschädigungen an Ihrem Möbelstück wenden Sie sich bitte direkt an Ihr Möbelhaus.

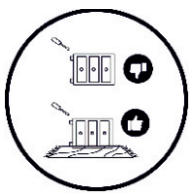
EN: Dear customer!
 Are you missing a fitting part or is it defective? No problem! Use our service card!
 Our direct ordering service for missing/defective fitting parts:
 Contact us by telephone on +499503/5033-114 or send us an e-mail to kundendienst@3s-frankenmoebel.de.
 Please include the following mandatory information: -> Order number, article number, number of the fitting part, missing/defective
 quantity, and the reason for the complaint, whether it is a defective or missing fitting part. Enter the required quantity.
 Mail us the completed service card to enable processing.
 For other complaints/damage to your furniture, please contact your furniture store directly.

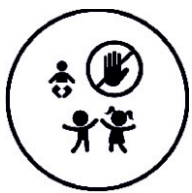
| | | | | | | | | | |
|--|---|---|---|--|--|---|--|--|---|
| 6X45  Ax8 |  Cx8 | 6X15  Dx16 | 3,5X20  Ex42 |  Fx6 |  Gx6 |  Hx1 |  Ix1 | 6X65  Jx4 | SW 4  x1 |
| 7X60  Kx4 | SW 5  x1 | Ø 28  Lx8 | 6x20  Gx20 | | | | | | |

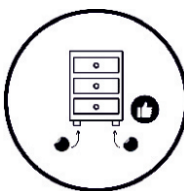
Grund der Beanstandung/Reason for complaint:
 Name/Name:.....Telefon/Phone:.....
 PLZ/Postal code.....Ort/ Place.....Hause-Nr./House-Nr:.....

| | | | | |
|---|---|---|--|---|
|  |  |  |  |  |
|  |  |  |  |  |
|  |  | | | |



MONTAGE ANLEITUNG - ASSEMBLY INSTRUCTIONS





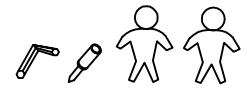



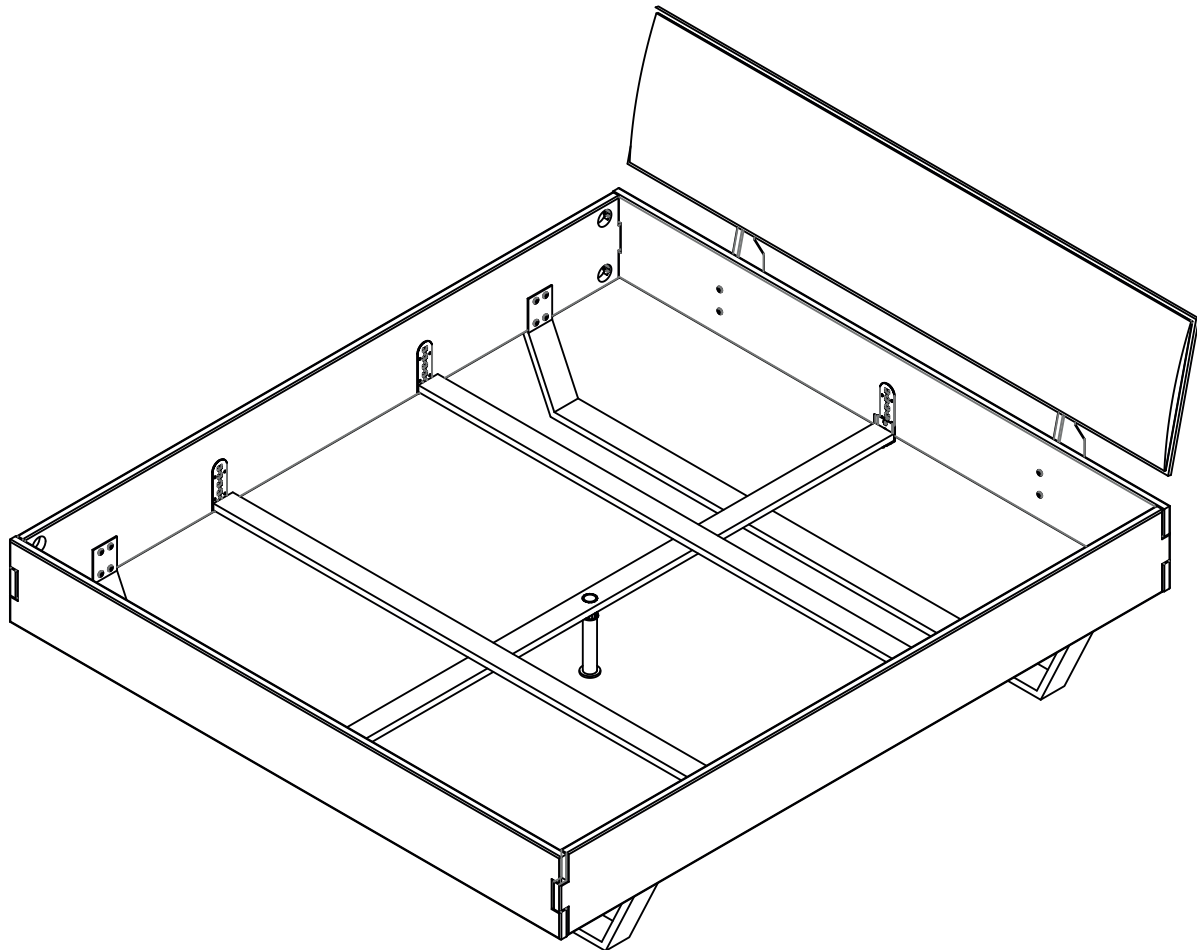

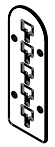

BETT 0873

BED 0873

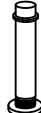

40 Minutes



| | | | | | | | | |
|---|--|--|--|---|--|---|---|--|
| 6X45  A x 8 |  C x 8 | 6X15  DX 16 | 3,5X20  EX 42 |  FX 6 |  GX 6 |  HX 1 |  IX 1 | 6X65  J x 4 |
| 7x60  K x 4 | SW 4  x 1 | SW 5  x 1 | Ø 28  LX 8 | | | | | |

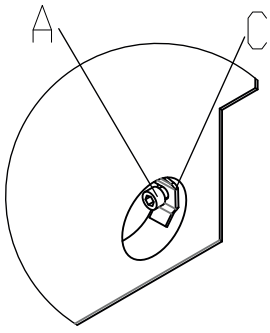

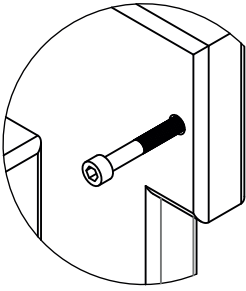

DETAIL A

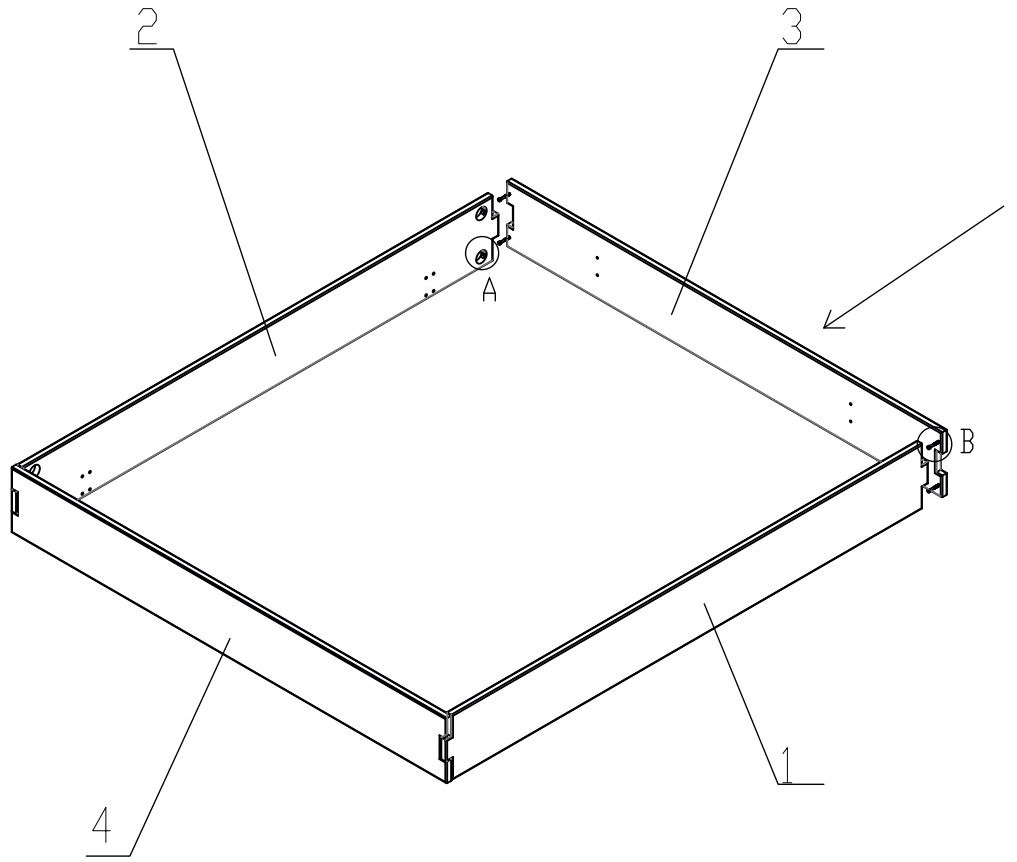

DETAIL B



1.

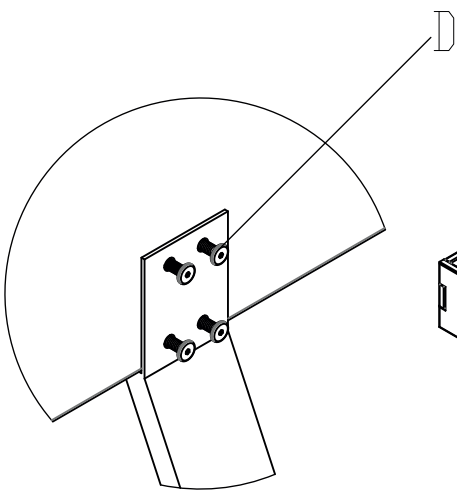

| | | |
|---|--|--|
| 6X45 | | SW 5 |
|  |  |  |
| Ax8 | Cx8 | x1 |

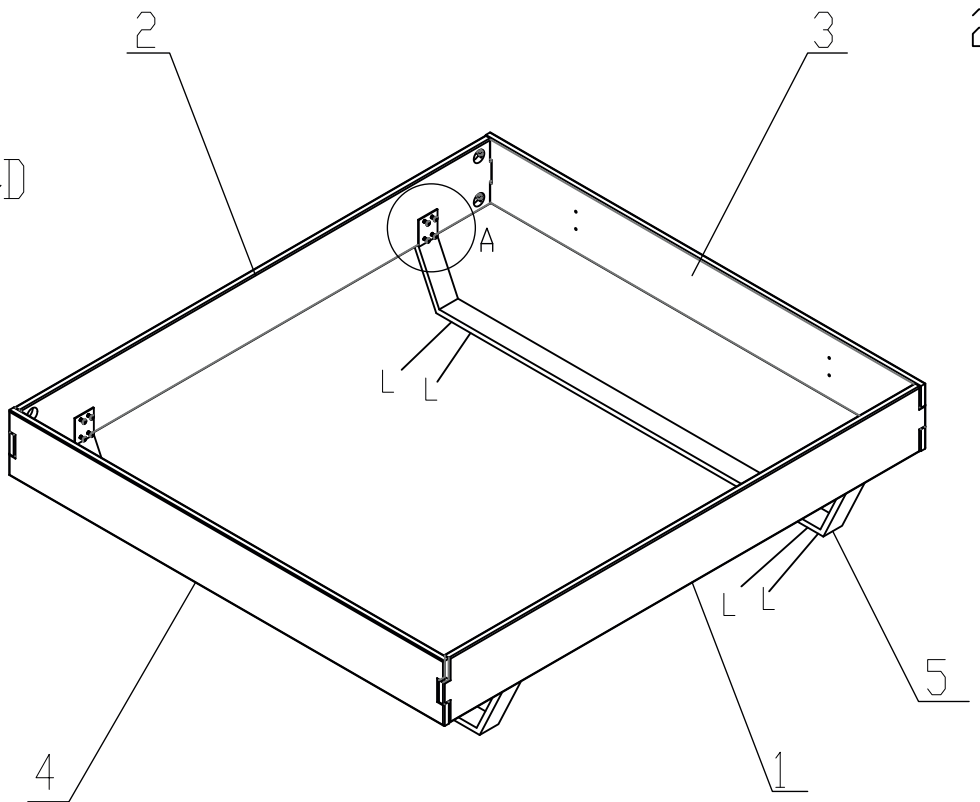

DETAIL A





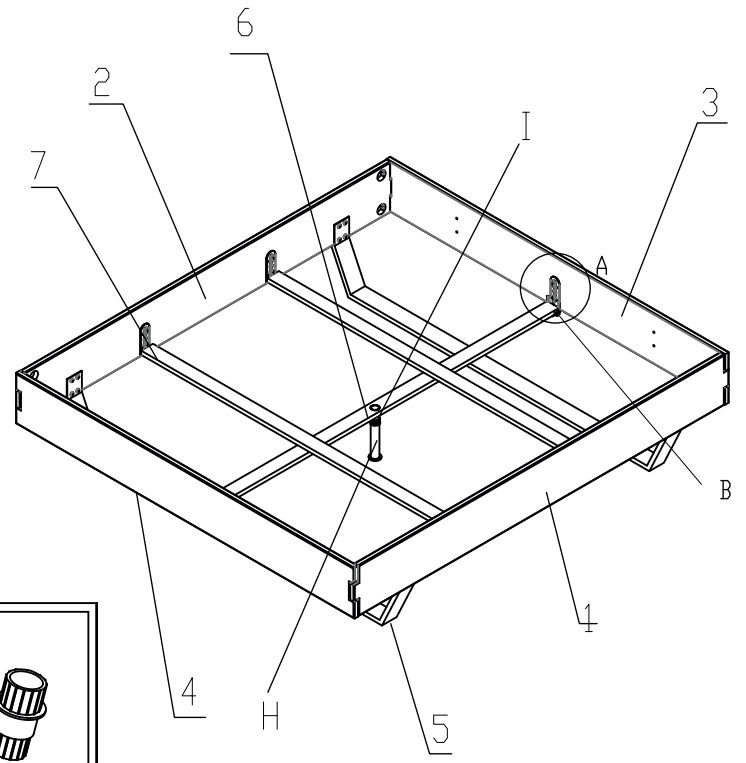
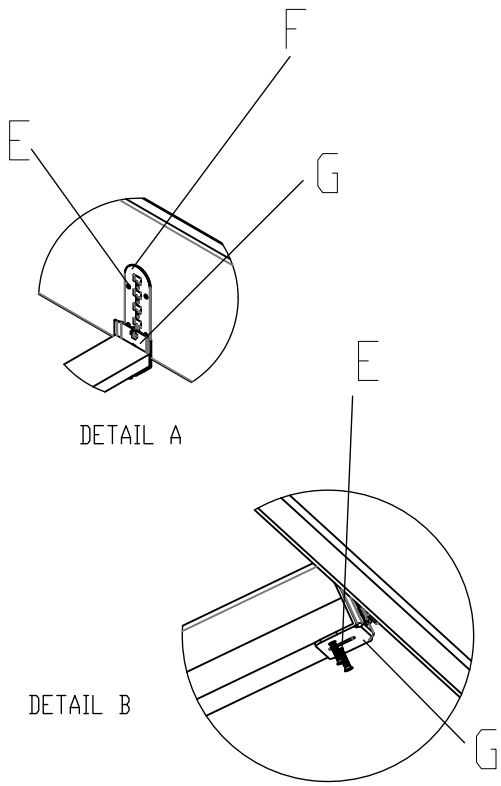

2.

| | | |
|--|---|---|
| 6X15 | SW 4 | Ø 28 |
|  |  |  |
| DX16 | | LX8 |

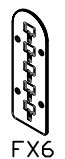

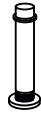
3.

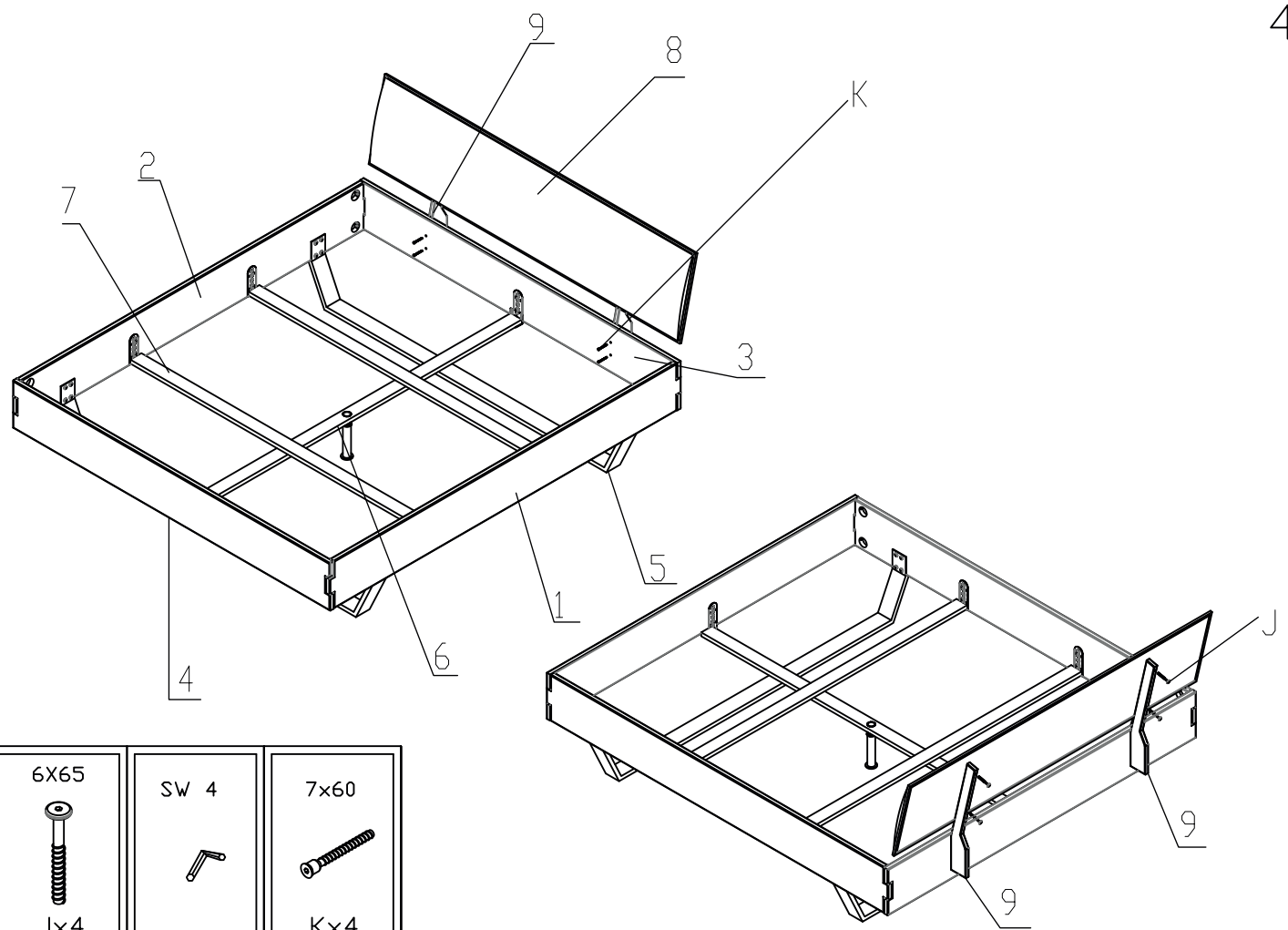

| | | | | |
|---|---|---|---|---|
| 3,5X20  EX42 |  FX6 |  GX6 |  HX1 |  IX1 |
|---|---|---|---|---|

4.



| | | |
|---|---|--|
| 6X65  Jx4 | SW 4  | 7x60  Kx4 |
|---|---|--|