

ArtikeLnr: MTA3ET12

# Service card

Name

Matadi

Typ

T12-Kombi-Vitrine

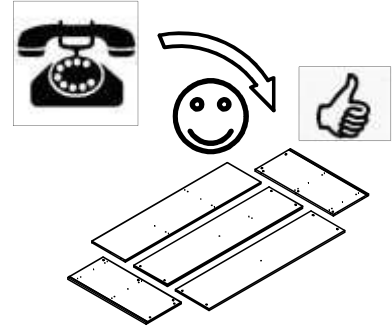
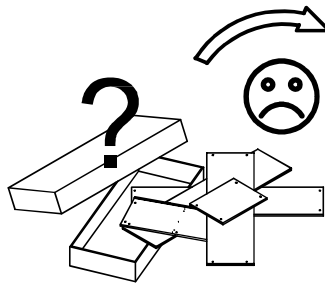
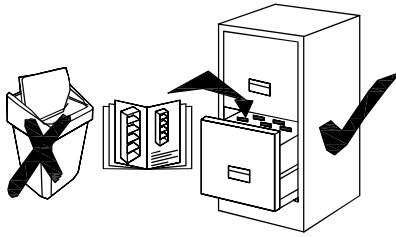

- ① 802x372x29
- ② 742x323x30
- ③ 764x351x30
- ④ 802x372x26
- ⑤ 1934x352x18
- ⑥ 1934x352x18
- ⑦ 1904x330x18
- ⑧ 473x320x18
- ⑨ 273x290x18
- ⑩ 272x290x18
- ⑪ 472x290x18
- ⑫ 1928x296x18
- ⑬ 496x496x18
- ⑭ 496x496x18
- ⑮ 250x250x37
- ⑯ 1921x780x3
- ⑰ 989x470x4
- ⑱ 989x160x4
- ⑲ 461x280x5

⑳ 764x333x333  
**Beleuchtung!!**

㉑ **Trafo!!**

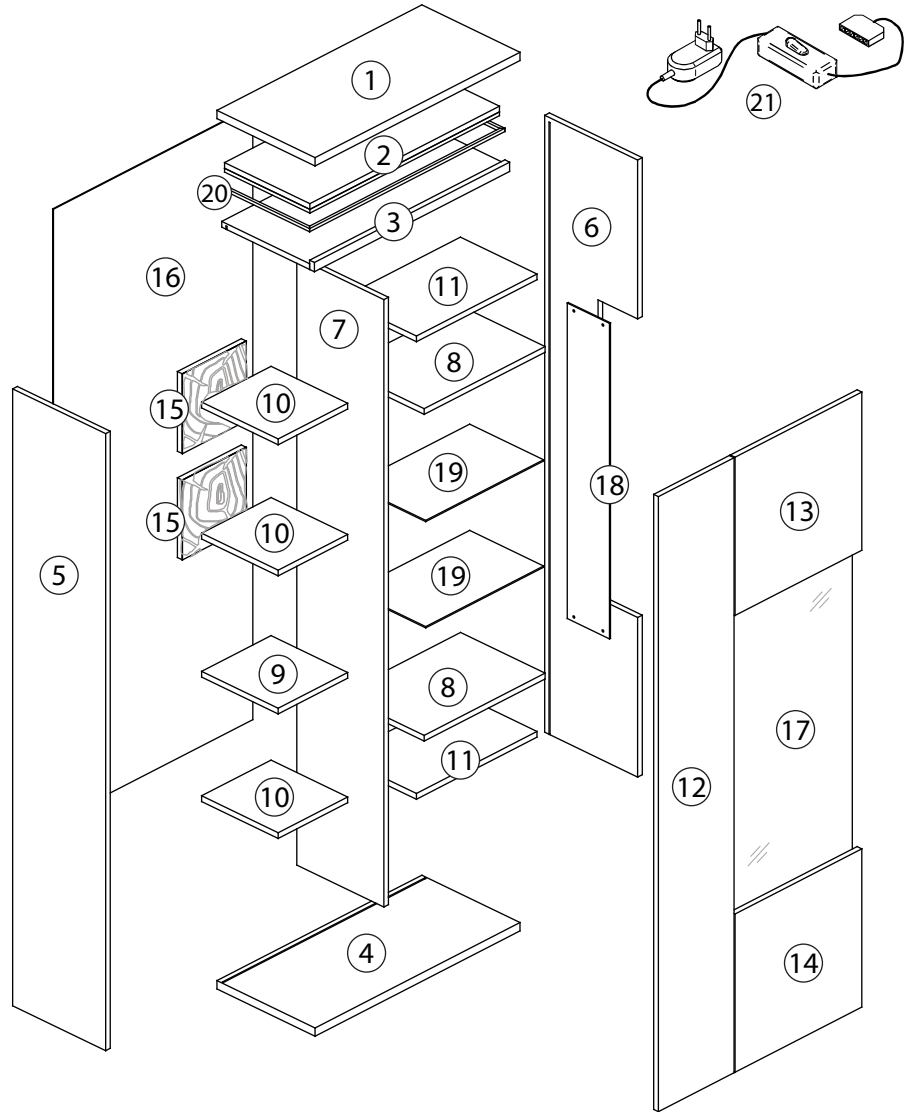

V1 Ø7/9x4	L2 L=42 mm	P 4x16 mm	R2	Z M4x25 mm	
M 3x16 mm	L1 Ø5	Q 4x25 mm	V 3x20 mm	M1	A2
I2 H=20	G Ø18	R 4x35 mm	W 4x20 mm	I1 L=50 mm	C2 T=0
A 8x30mm	H Ø5x34	S 4x45 mm	X 4x16 mm	K1	D2 Glissando
D Ø15	L 77x20x15 mm	U 5x60 mm	C1 M4x10 mm	U1	E2 Ø7x1,5

# MONTAGEANLEITUNG

Modellname: **MATADI**

TYPE T12-Kombi-Vitrine/ArtikeLnr: MTA3ET12

# 1/2

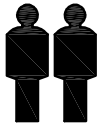

2 Persons

20min

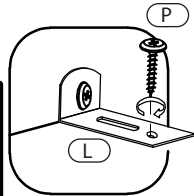
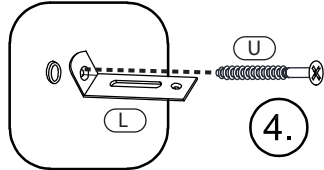
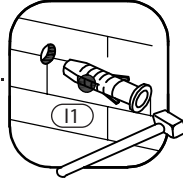
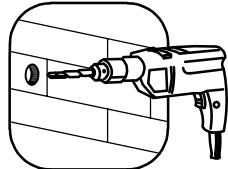
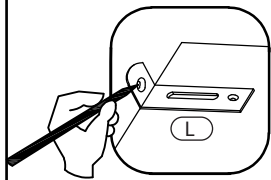
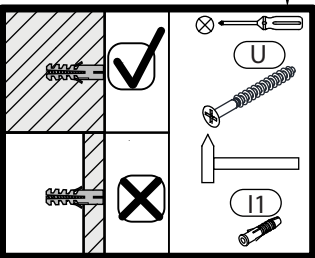
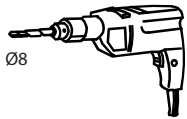
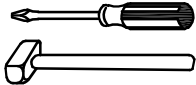
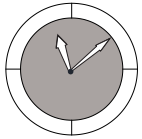

1.

2.

3.

4.

5.

cca. 100mm

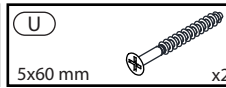
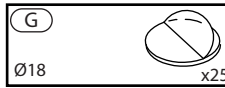
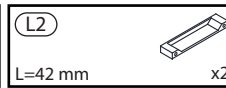
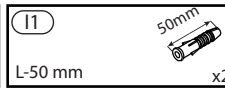
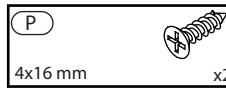
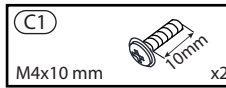
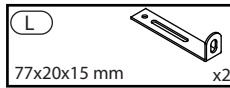
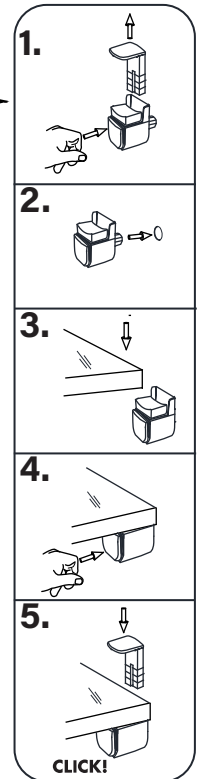
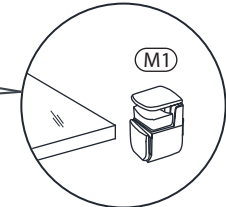
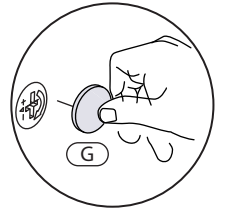
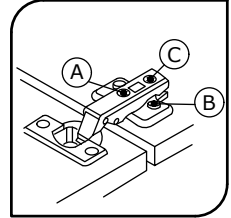
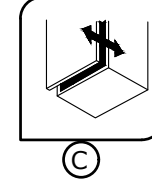
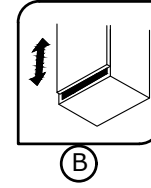
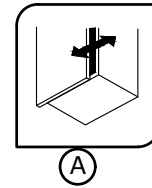
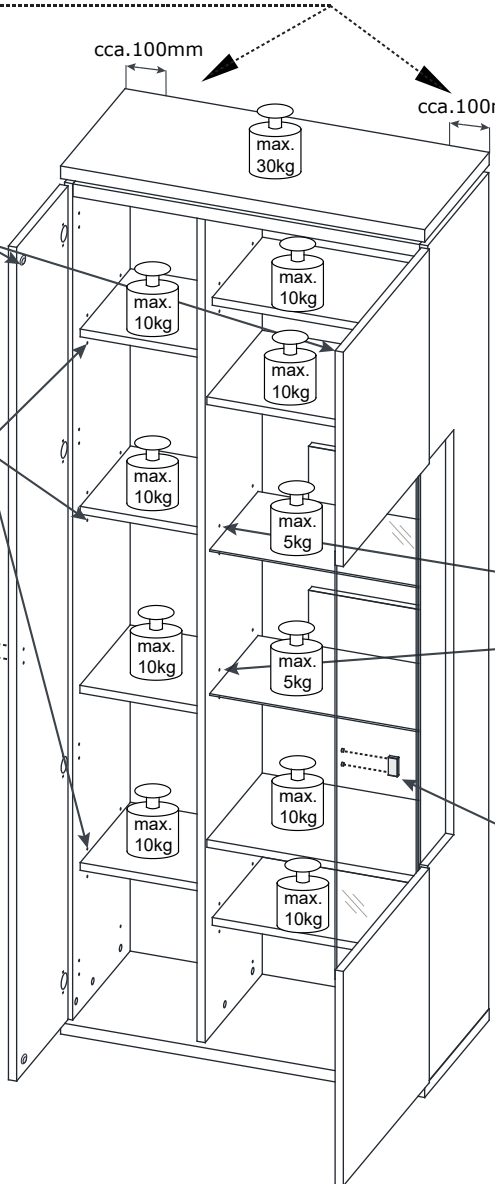

CLICK!

Modellname: **MATADI**

# MONTAGEANLEITUNG

TYPE T12-Kombi-Vitrine/ArtikeLnr: MTA3ET12

## 2/2

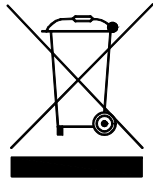

Das Symbol der durchgekreuzten Mülltonne bedeutet, dass elektrische sowie elektronische Teile nicht mit dem Hausmüll entsorgt werden dürfen. Bitte alle elektrischen/elektronischen Teile wie in der Aufbauanleitung gezeigt abmontieren und getrennt entsorgen.

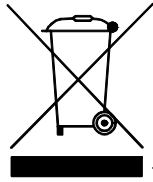

The crossed-out bin means that this product includes electrical and electronic pieces that must not be disposed of in the regular domestic waste. Please remove all electric/electronic equipment as described in the AI and dispose separately.

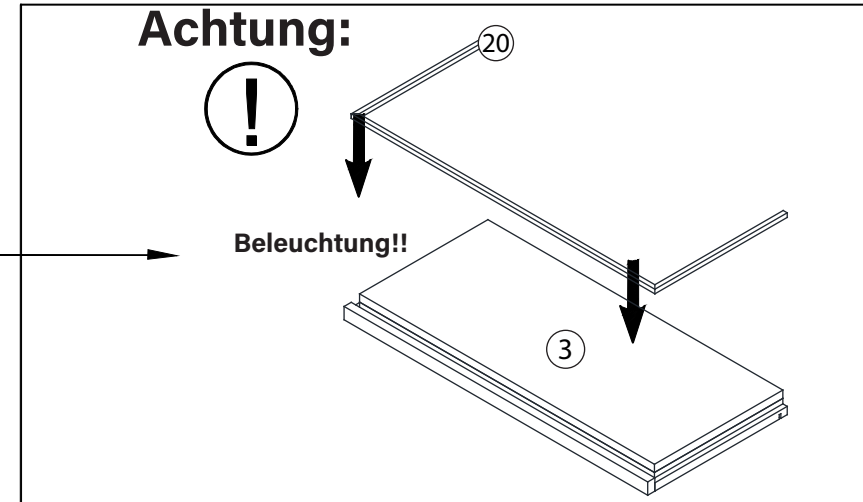

3

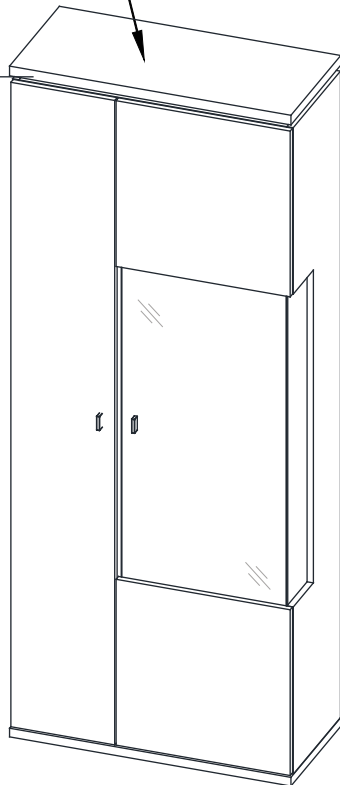

**Achtung:**

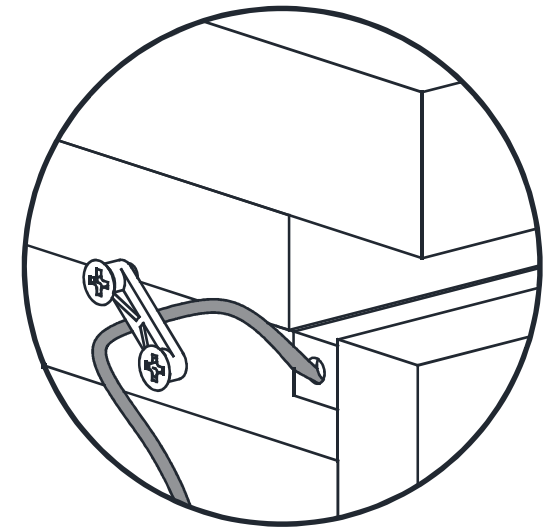

Modellname: **MATADI**

# OPTIONAL

TYPE T12-Kombi-Vitrine/ArtikeLnr: MTA3ET12

# 1/2

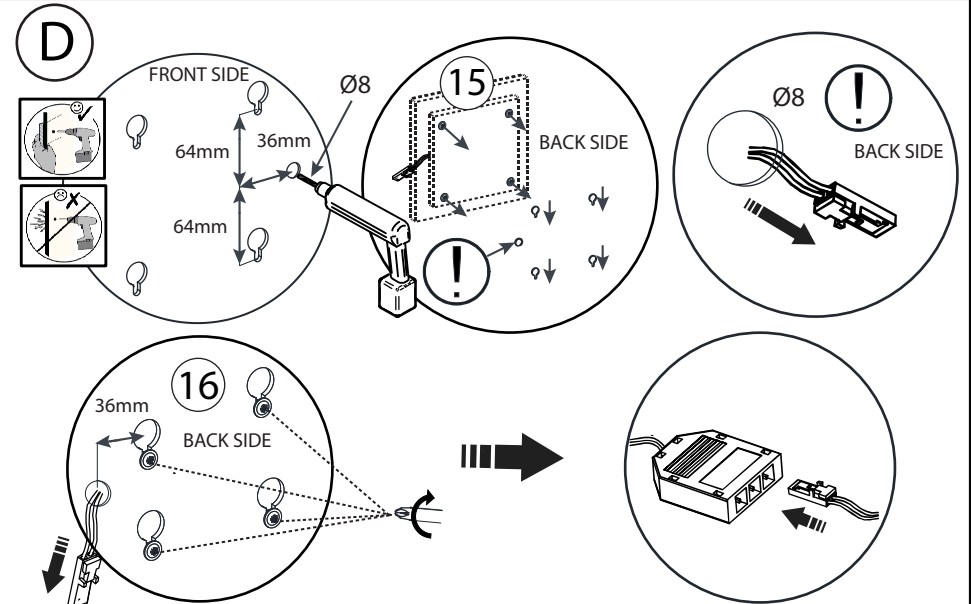
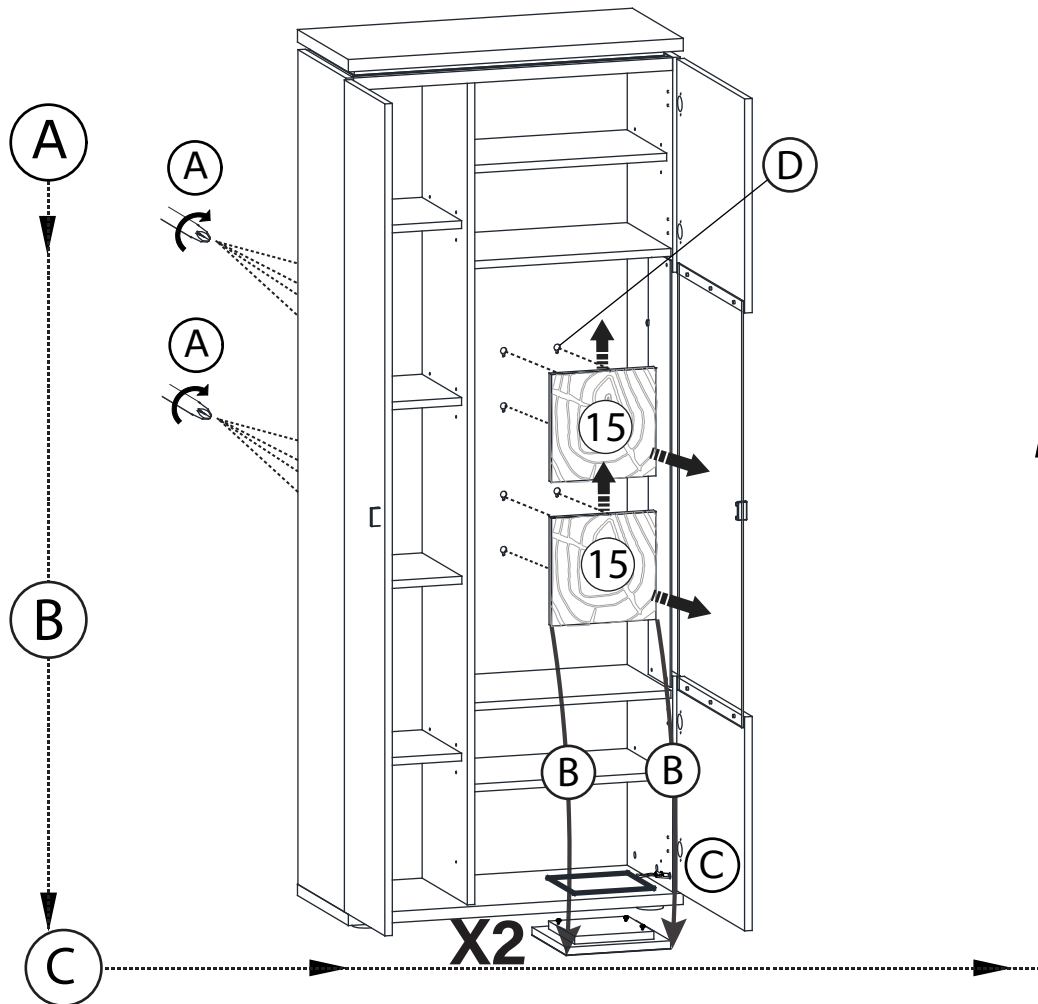

## OPTIONAL LED Band

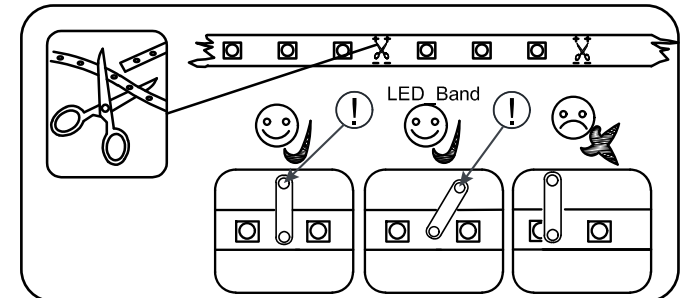
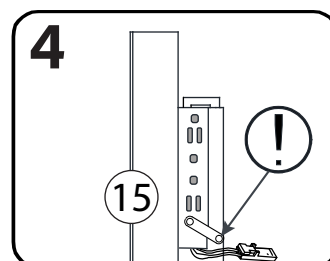
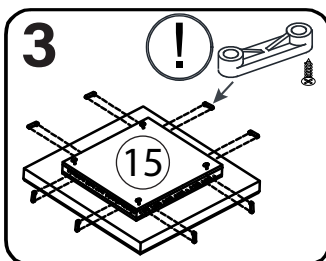
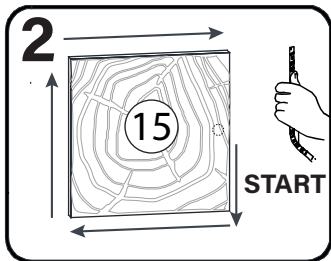
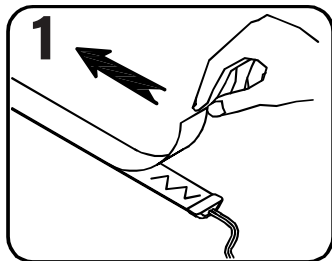

Modellname: **MATADI**

# OPTIONAL

TYPE T12-Kombi-Vitrine/ArtikeLnr: MTA3ET12

# 2/2

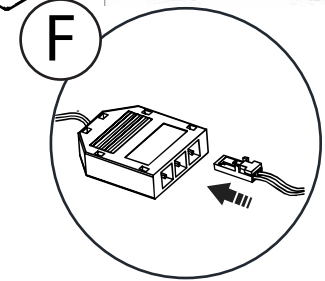
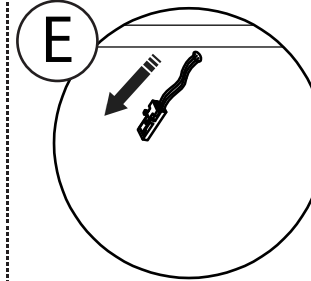
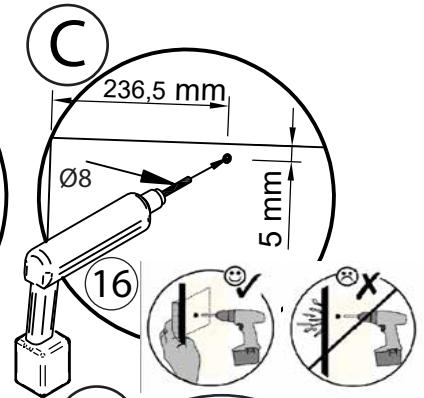
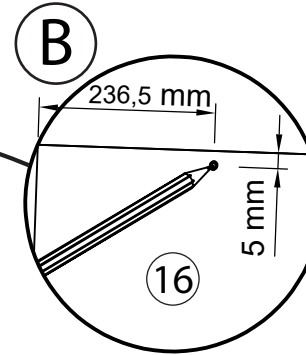
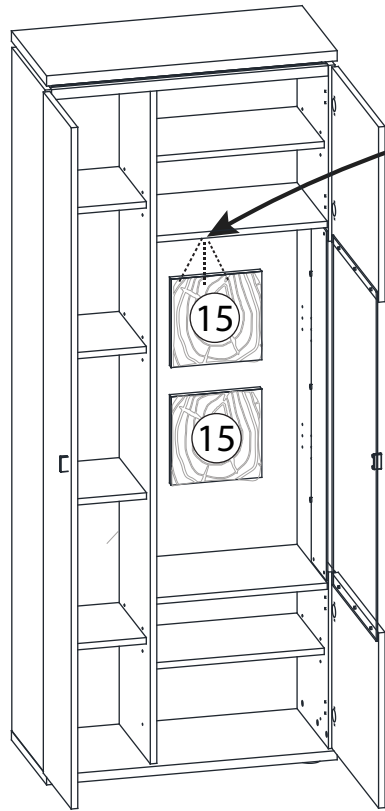

Montage- und Betriebsanleitung für Leuchte "LED Spot Set"

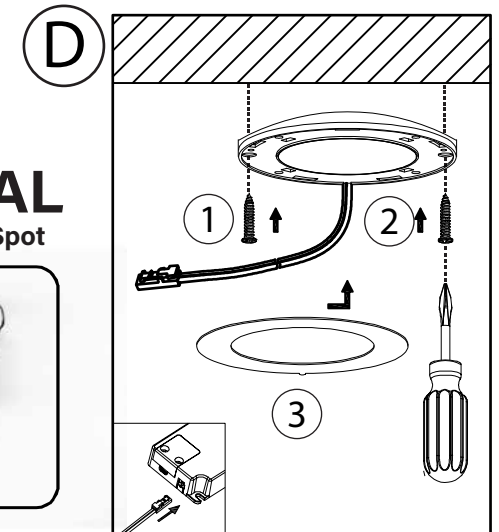
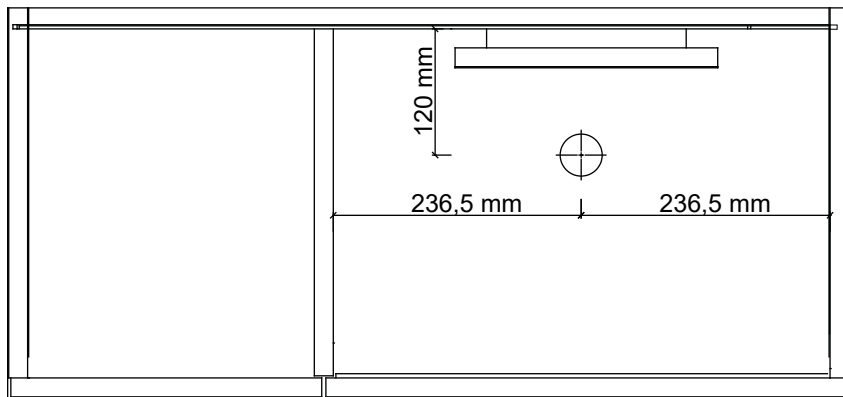

**OPTIONAL**  
LED Flat Power Spot



05021ZB