

377762-1

Pflegehinweise - Care Instructions - Conseil d'entretien - Onderhoudsinstructies - Istruzioni per l'uso

DEUTSCH

LACKIERTES HOLZ

Mit Staubtuch abstauben.
Regelmäßig mit feuchtem
Tuch in Richtung der
Maserung abwischen. Dauern
ässe vermeiden.

METALL

Einfach mit feuchtem Tuch
abwischen, danach trocken
reiben. Bei Chrom und Kupfer
regelmäßig mit speziellen
Pflegemittel polieren.

FRANÇAIS

BOIS PEINT

Dépoussiérer avec un chiffon.
Essuyer régulièrement avec
un chiffon humide dans le
sens des veinures. Eviter le dé
pôt durable d'humidité.

MÉTAL

Nettoyer avec un chiffon
humide. Frotter ensuite pour sé
cher. Pour le chrome et le
cuivre, polir régulièrement
avec un produit d'entretien
spécial.

ITALIANO

LEGNO VERNICIATO

Pulire con un panno per la
rimozione della polvere. Pulire
periodicamente-e con regolarità
con un panno umido, in
direzione delle venature del
legno. Evitare bagnato e
umidità persistenti.

METALLO

Pulire con un semplice panno
umido e asciugare. Per la
pulizia di rame e superfici
cromate utilizzare
regolarmente detergenti
specifici.

ENGLISH

PAINTED WOOD

Dust off regularly. Use slightly
wet cloth once in a while.
Cleaning shall be performed in
the direction of the wood
texture. Avoid stagnant
moisture.

METAL

Use slightly wet cloth for
regular cleaning. Dry
afterwards immediately.
Periodically use special
cleaning agents especially for
chromium and copper.

NEDERLANDS

GESCHILDERD HOUT

Stof het product met enige
regelmaat af. Gebruik van tijd
tot tijd een vochtige doek om
het product schoon te maken.
Voer de reiniging altijd uit in
de richting van de
houtstructuur. Vermijd
stagnerende vocht.

METAAL

Met een vochtige doek
schoonmaken en daarna met
een droge doek afnemen. Bij
chrom en koper regelmatig
met speciale
reinigingsmiddelen.

Sicherheitshinweis - Safety Warning - Avis de sécurité - Beveiligingsmededeling - Avviso di sicurezza

DEUTSCH

Bitte benutzen Sie dieses Produkt ausschließlich für seinen ihm zugedachten Zweck.

Holz als hygroskopisches Naturprodukt ist natürlichen Schwankungen (Temperatur, Feuchtigkeit) ausgesetzt. Veränderungen in Form und Farbe je nach Holzart, Bauweise und Standort sind normal.

Optimales Raumklima: 18-21°C, 45-55% Luftfeuchte.

Kastenmöbel können umfallen und zu schweren Verletzungen führen, Bitte nutzen Sie das beigefügte Wandbefestigungs set, um diese Gefahr zu vermeiden.

UV-Strahlen können die Oberfläche schädigen! Achten Sie auf einen möglichst schattigen Aufstellort.

ENGLISH

Use the product for its intended purpose only!

As wood is a hygroscopic natural product it is depending on shifts in temperature and humidity. Range depending on type of wood, construction, and place of location.

Optimum conditions:
temperature: 18-21°C (64-70°F)
air humidity: 45-55%.

Free standing cabinets can tip over and cause severe harm. Please use attached wall-mount kit to avoid this hazard.

Do not expose product to direct sunlight to avoid discoloration of surface.

FRANÇAIS

Utiliser uniquement le produit pour son usage prévu!

Comme produit naturel hygrosopique, exposé à des variations naturelles (température, humidité). normales de forme et couleur selon le type de bois, de construction et de lieu.

Climat intérieur optimal: 18-21°C 45-55% d'humidité.

Les éléments peuvent basculer et provoquer de graves blessures. Afin d'éviter tout danger, veuillez utiliser le kit de fixation murale joints.

N'exposez pas les produits au soleil, cela permet d'éviter la décoloration de la surface.

NEDERLANDS

Gebruik dit product alleen waarvoor het bedoeld is!

Aangezien hout een hygrosopisch natuurproduct is, is dit vatbaar voor verandering in temperatuur en luchtvochtigheid.

De optimale omstandigheden zijn tussen de 18 – 21 graden celcius (64 – 70 graden F) en een luchtvochtigheid van tussen de 45% en 55%.

Vrijstaande kasten kunnen omvallen en letsel veroorzaken. Gebruik alstublieft de bijgeleverde wandmontagekit om letsel te voorkomen.

Vermijd direct zonlicht om verkleuring te voorkomen.

ITALIANO

Utilizzare il prodotto unicamente per la destinazione d'uso prevista.

Questo prodotto é, per via delle sue naturali proprietà igrosopiche, soggetto a variazioni naturali di forma e colore in funzione del tipo di legno, della struttura e del suo posizionamento (oscillazioni di temperatura e umidità).

Condizioni ideali: 18-21°C, 45-55% di umidità.

Mobili scaffale possono cadere e procurare gravi lesioni. La invitiamo a utilizzare il kit di fissaggio incluso per assicurare i mobili alla parete e evitare pericoli.

Per evitare fenomeni di scolorimento delle superfici, non esporre il prodotto direttamente ai raggi solari.



1

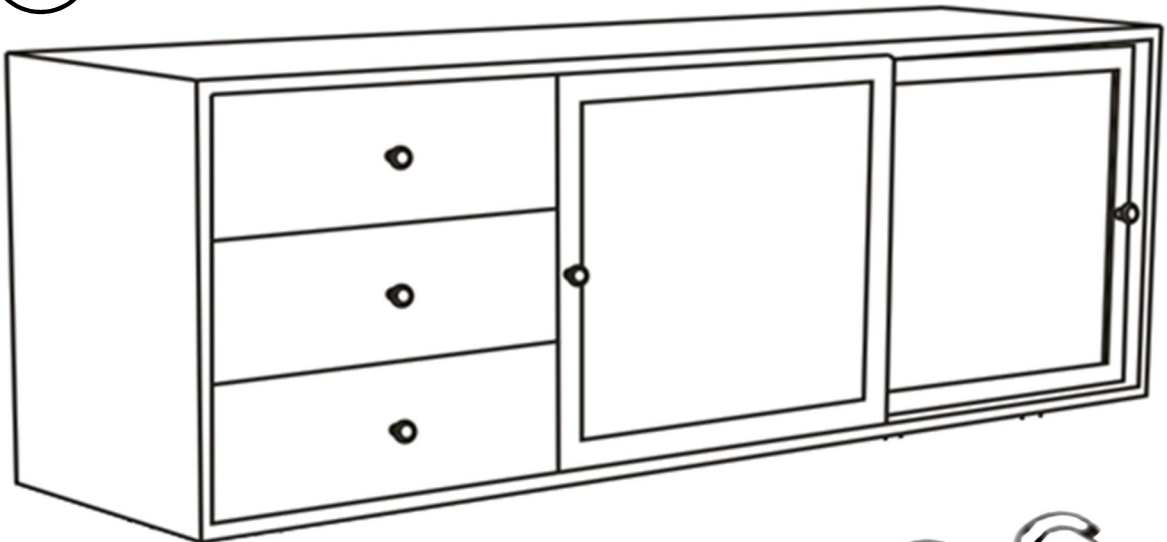

2



2

Kleinteile

Petits éléments

Piccoli pezzi

Small parts

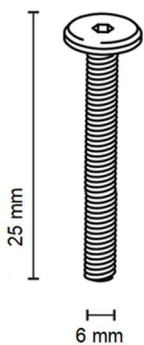

(A) X 12



(B) X 12

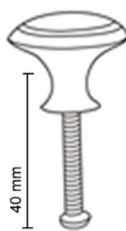

(C) X 3

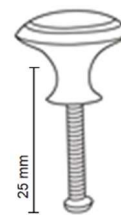

(D) X 2



(E) X 1

01

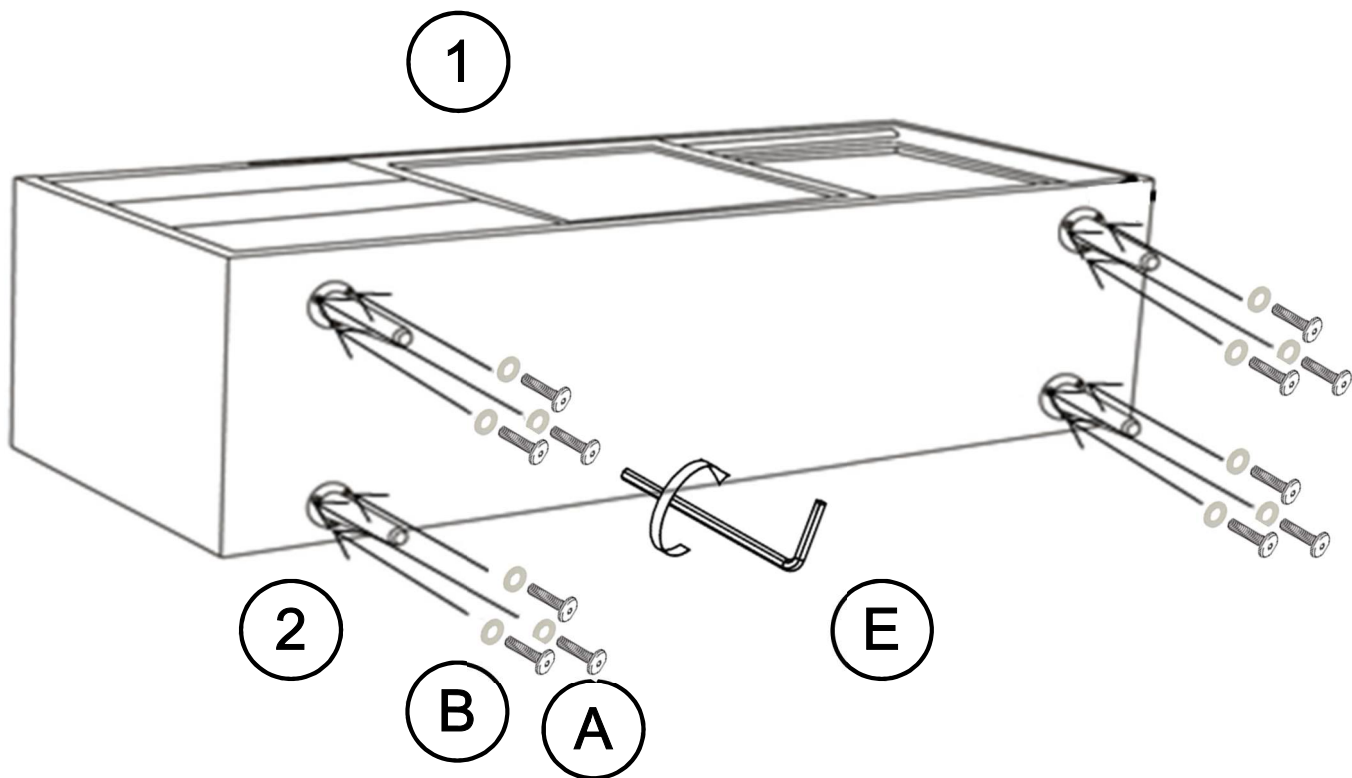

02

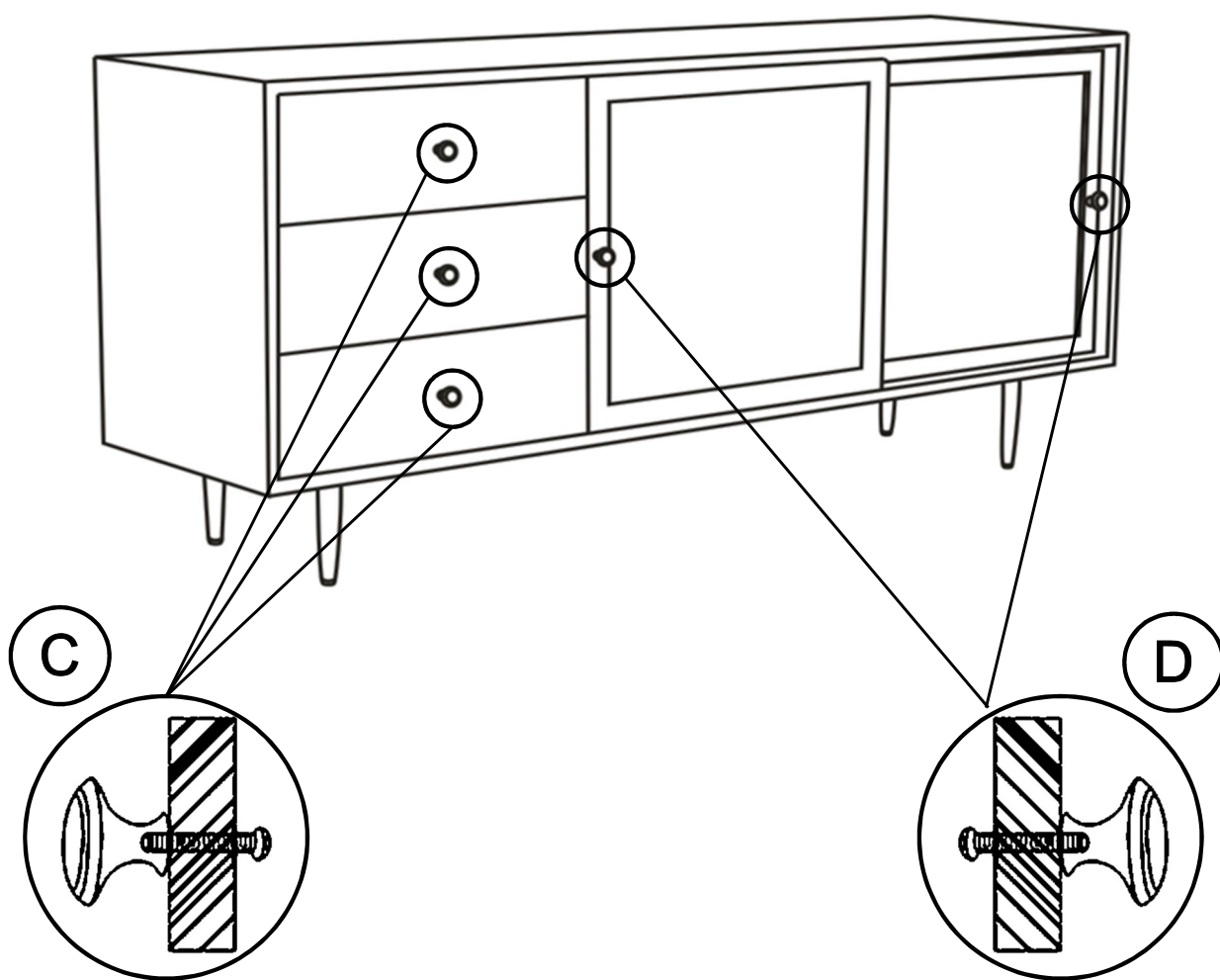

03

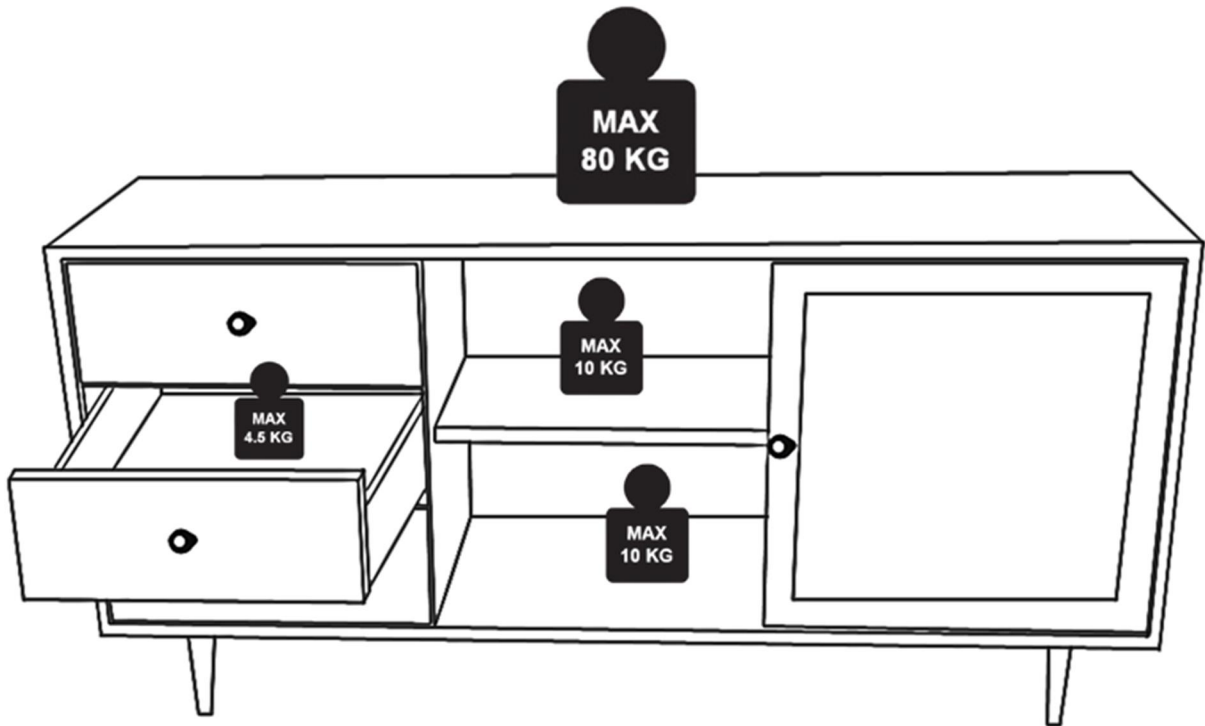
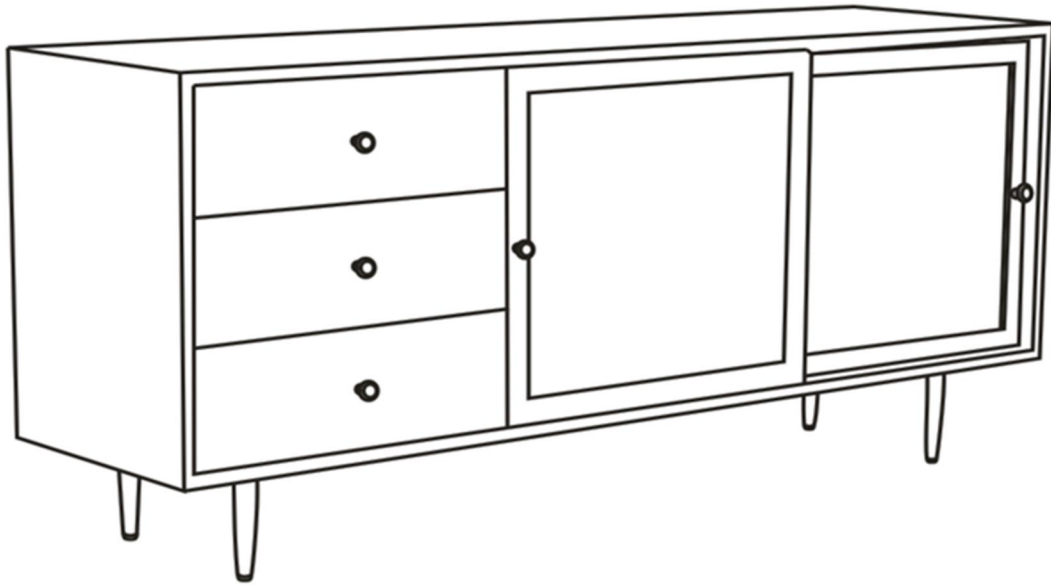

Made in Indonesia

Kippschutz - Anti tipper - Instruction du anti-pointe - Stall preventie -
Prevenzione di stallo



Kleinteile

Petits éléments

Piccoli pezzi

Small parts

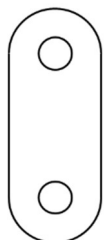

(A) X 4

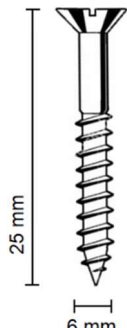

(B) X 2

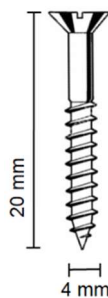

(C) X 2



(D) X 2



(E) X 2

01

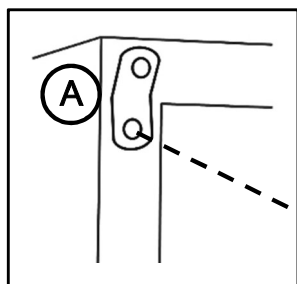

(C)

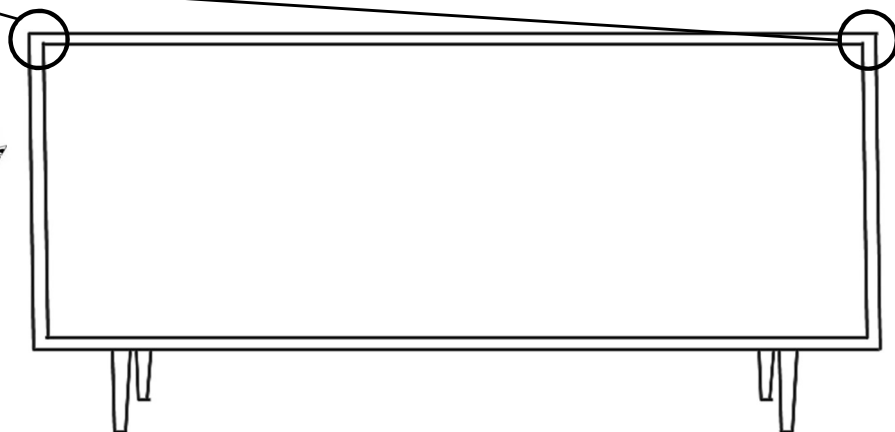

02

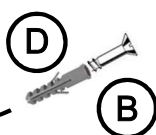
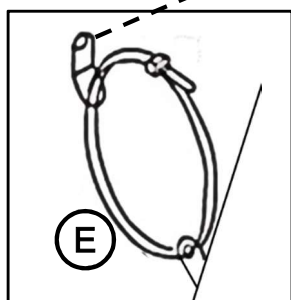

(B)

