

Röhr-Bush GmbH & Co. KG
Dammstraße 32
33397 Rietberg
Germany
Fon +49 (0) 2944 981 198
Fax +49 (0) 2944 981 310

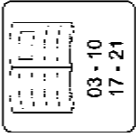

03 - 10
17 - 21

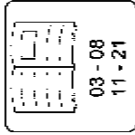
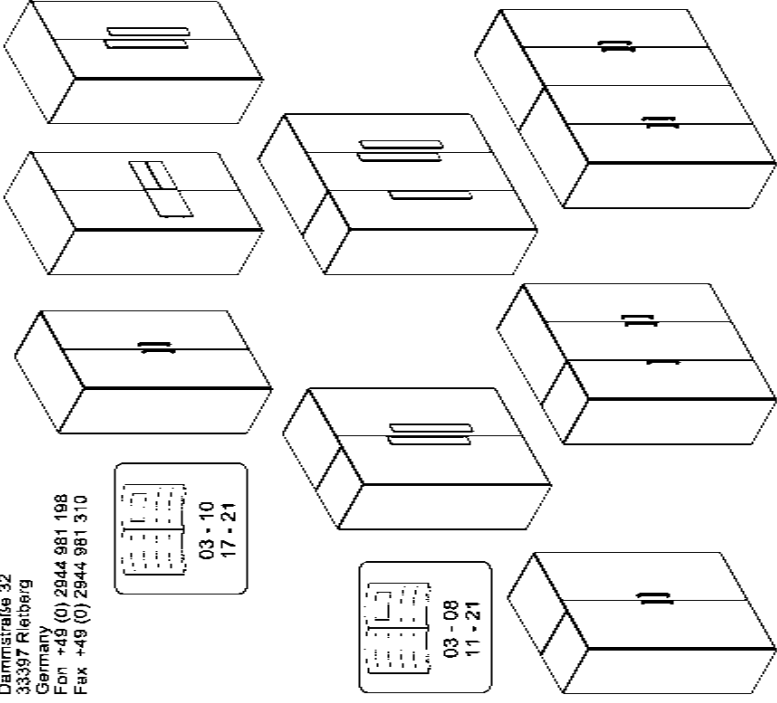

03 - 08
11 - 21

Bitte unbedingt lesen: Bei Nichtbeachtung können wir keine Gewährleistung übernehmen!
Bitte bewahren Sie diese Montageanleitung für die Produktkennzeichnung (Produktsicherheitsgesetz) und für evtl. spätere Rückfragen (wie z. B. Demontage) auf.
Bei Weitergabe bzw. Übergabe des Artikels übergeben Sie auch diese Montageanleitung.
Attention! It is essential to read this. In case of non-compliance we cannot accept any liability.
Please retain this assembly instruction for product identification and all future references e.g. disassembly.
With all transfers or deliveries of this item this assembly instruction should always be forwarded.

0091020

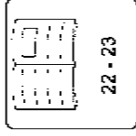

22 - 23

geteilte Türen
two part doors

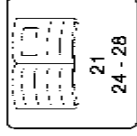
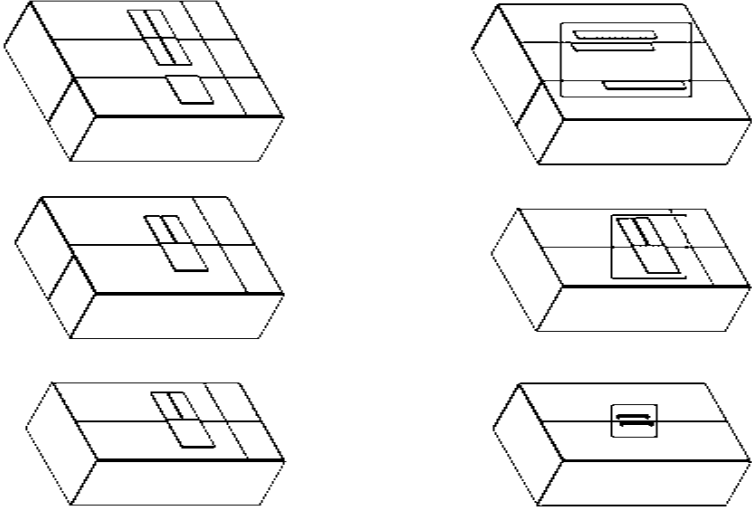

21
24 - 28

Griffe
handles

02 096098		02 096079		02 096030	
02 096530		02 096420		02 097108	
02 066508		02 096232		02 096449	
02 096489		02 9E3279		02 960384	
02 096485		02 9E1946		02 096449	
02 096489		02 9E1946		02 960384	
02 096489		02 9E1946		02 960384	
02 096489		02 9E1946		02 960384	
02 096489		02 9E1946		02 960384	
02 096489		02 9E1946		02 960384	

Griffe variieren in
Form und Position
in den Programmier-
Produktionsprozessen
können aufgrund von
abstrakten
Produktionsprozessen
ein Übermaß an
Baugteilen entstehen!
The content of fittings
may be higher than listed
because of universal
fitting-packages!

Position and Design of
Handles can be
different from shown!

Beachtungen können aufgrund von abstrakten
Produktionsprozessen ein Übermaß an
Baugteilen entstehen!
The content of fittings
may be higher than listed
because of universal
fitting-packages!

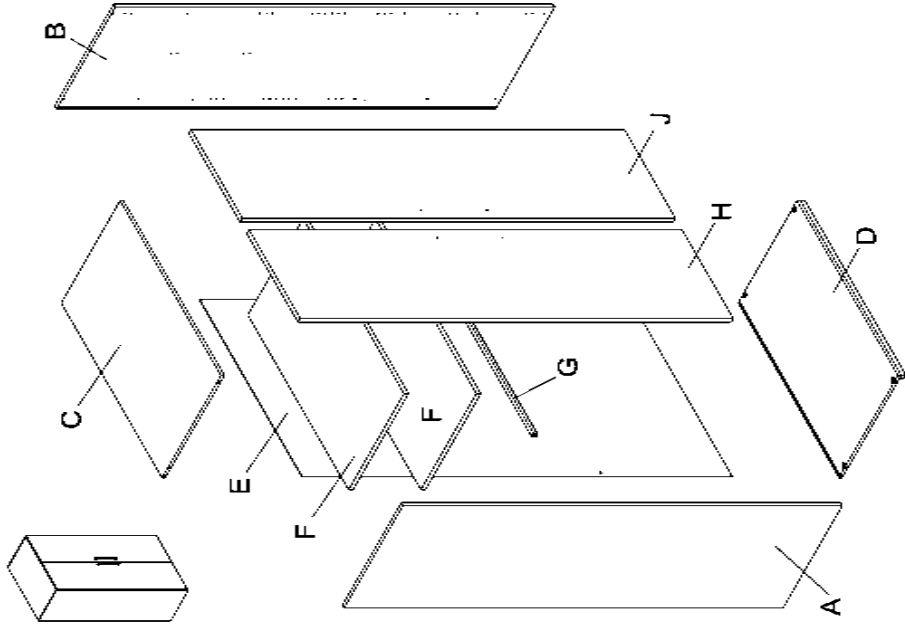
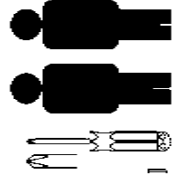

röhr

Montageanleitung
A04182.05

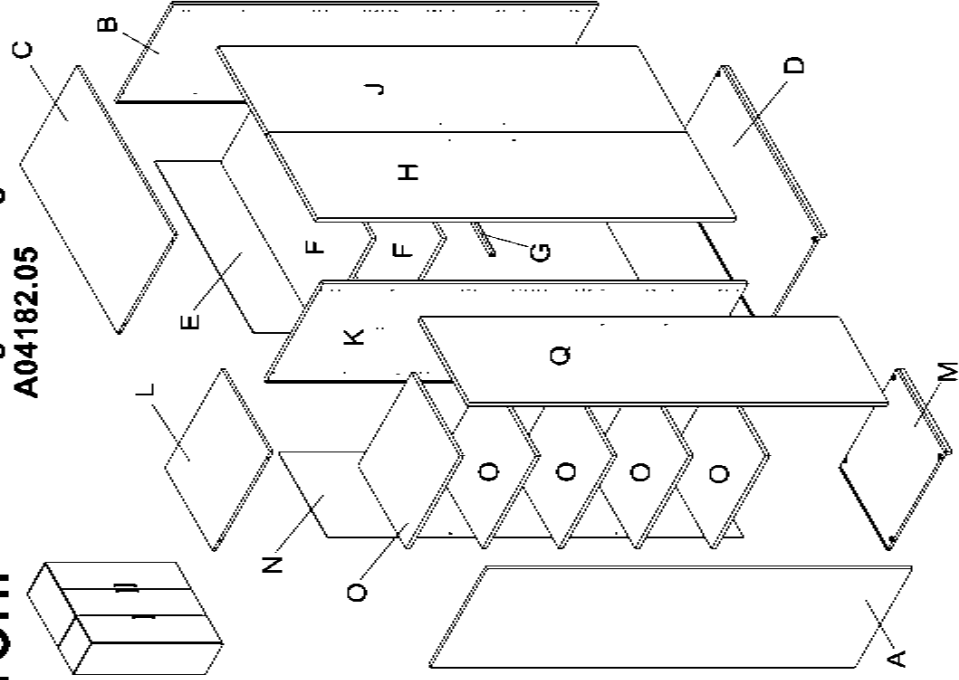
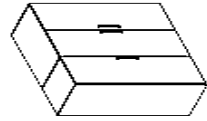

röhr

Montageanleitung
A04182.06



02096088
(2 X)

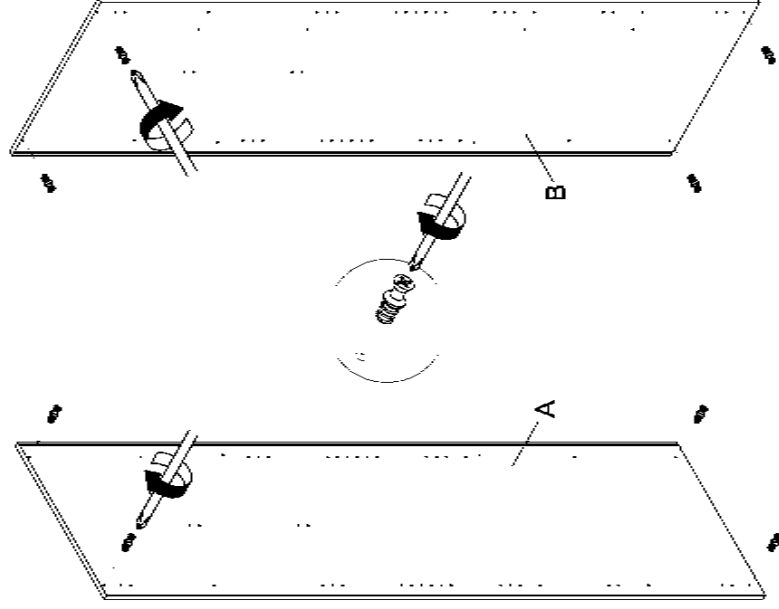

röhr

Montageanleitung
A04182.07

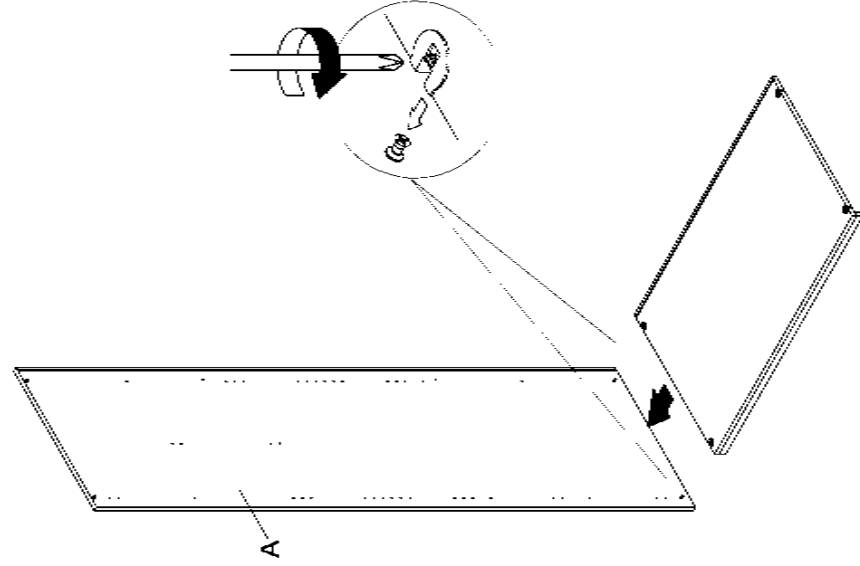

röhr

Montageanleitung
A04182.08

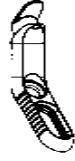

02096038
(2 X)



02096530
(2 X)

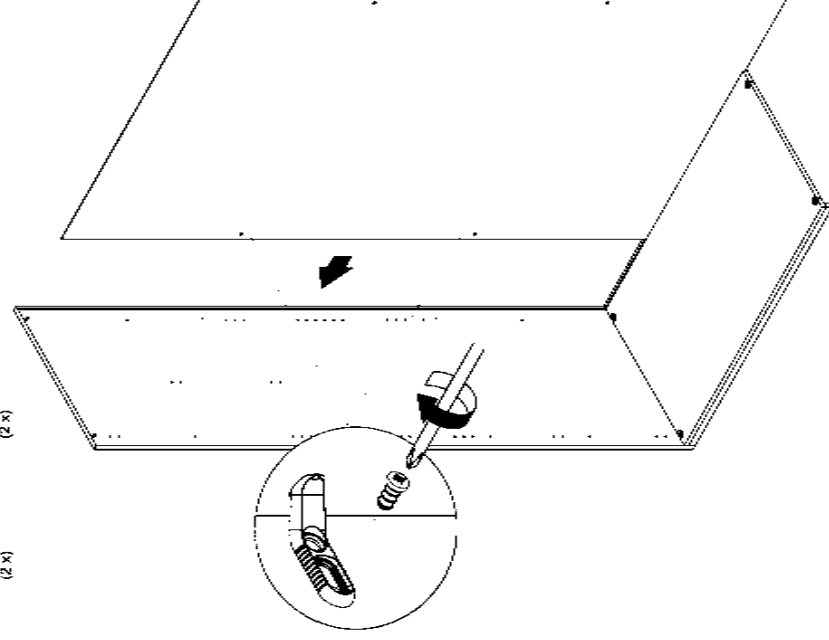

röhr

Montageanleitung
A04182.09

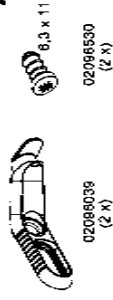
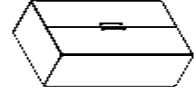

2.

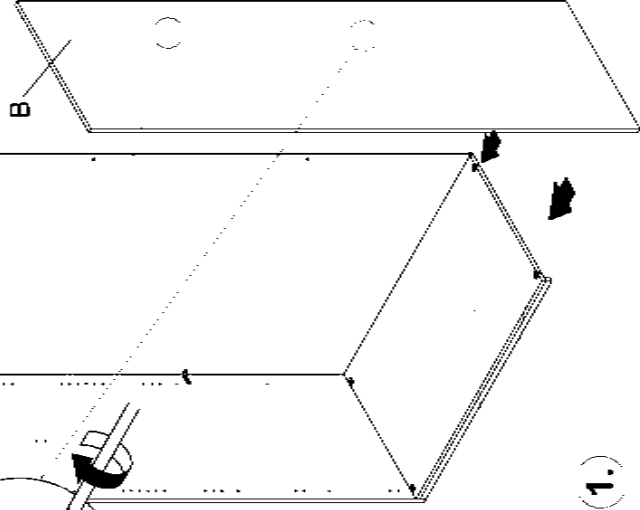
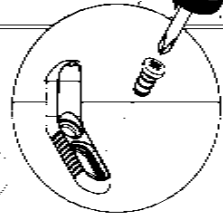

1.

Montageanleitung
A04182.10

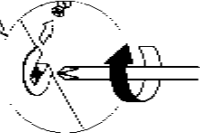
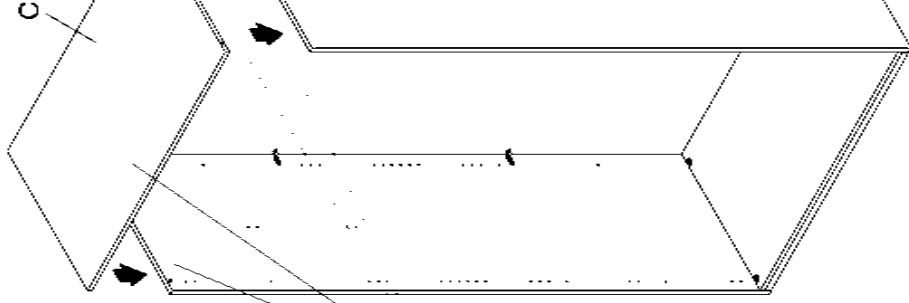
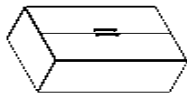

röhr

Montageanleitung
A04182.11

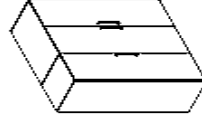

2.

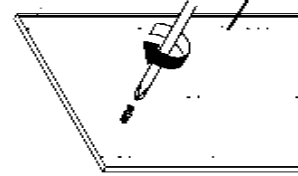

DREHEN

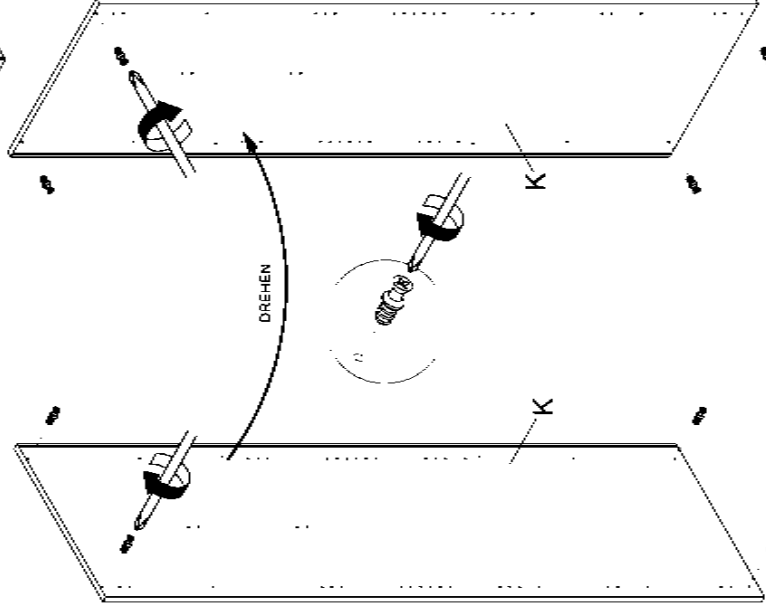

röhr

Montageanleitung
A04182.12

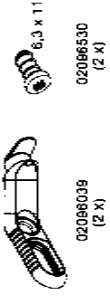
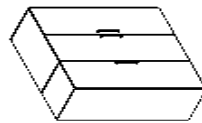

2.

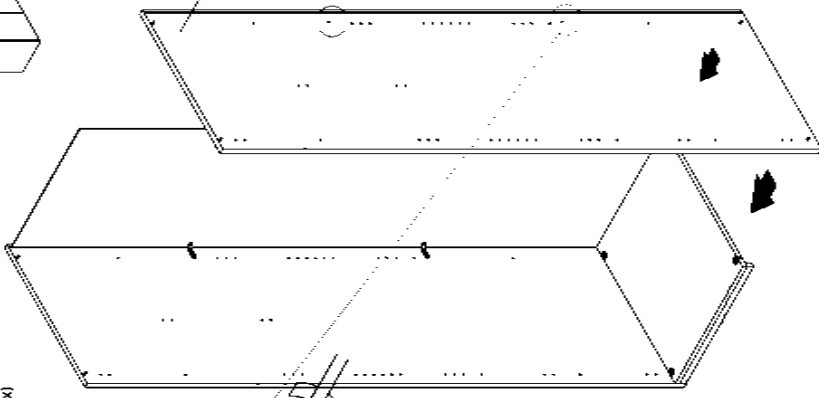
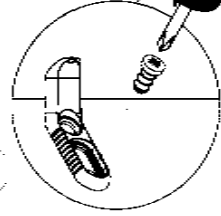

1.

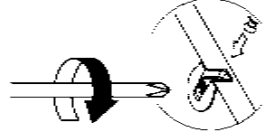

röhr

Montageanleitung
A04182.14

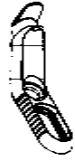

02098036
(2 x)



02096530
(2 x)

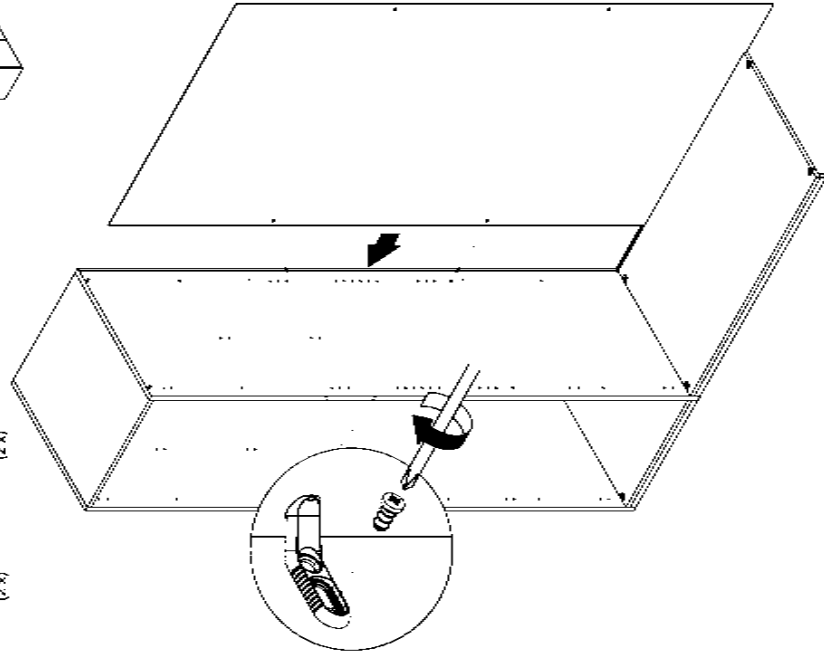
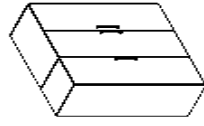

röhr

Montageanleitung
A04182.16

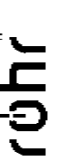

02098036
(2 x)



02096530
(2 x)

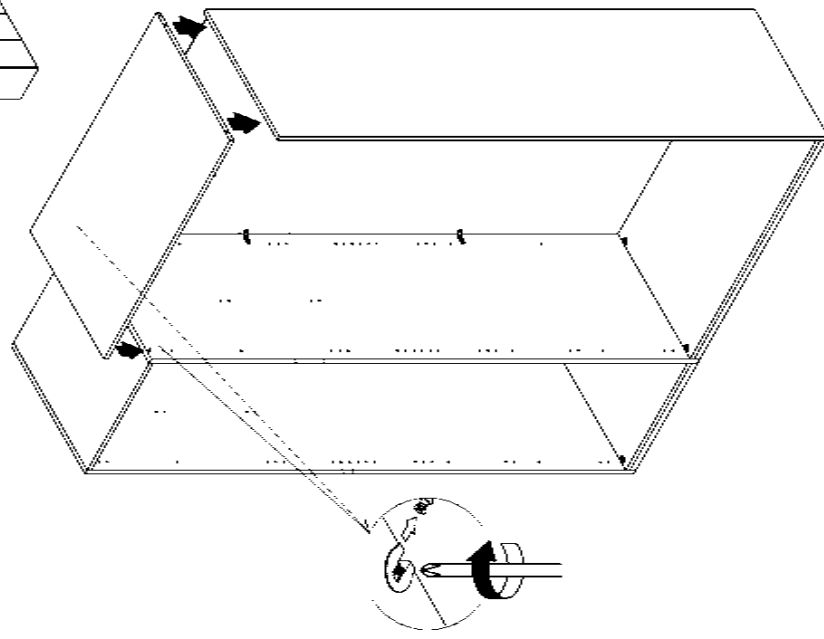
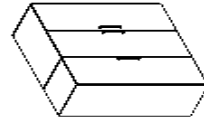

röhr

Montageanleitung
A04182.13



02098036
(2 x)

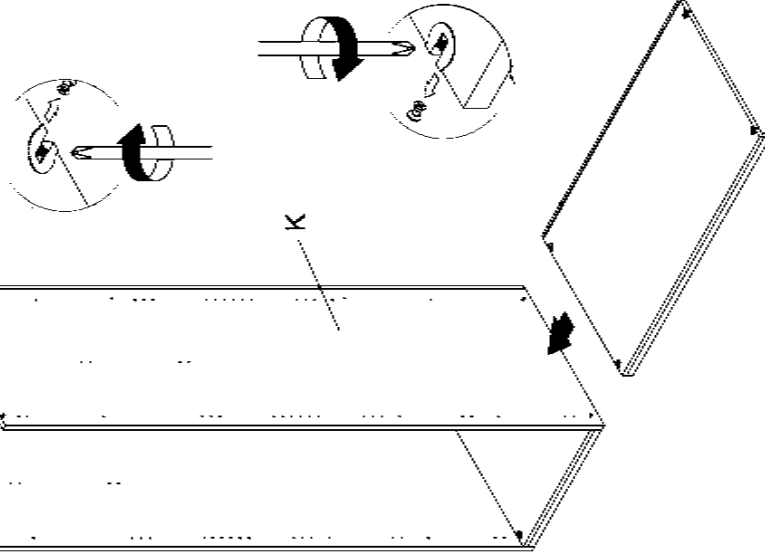
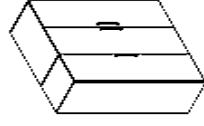

röhr

Montageanleitung
A04182.15

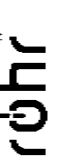

02098036
(2 x)



02096530
(2 x)

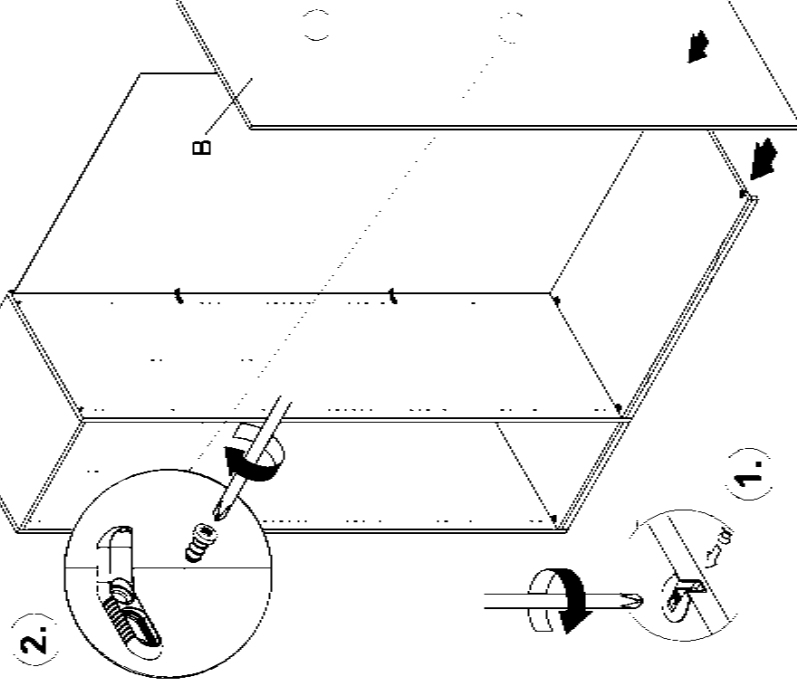
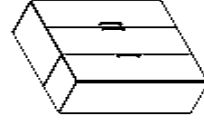

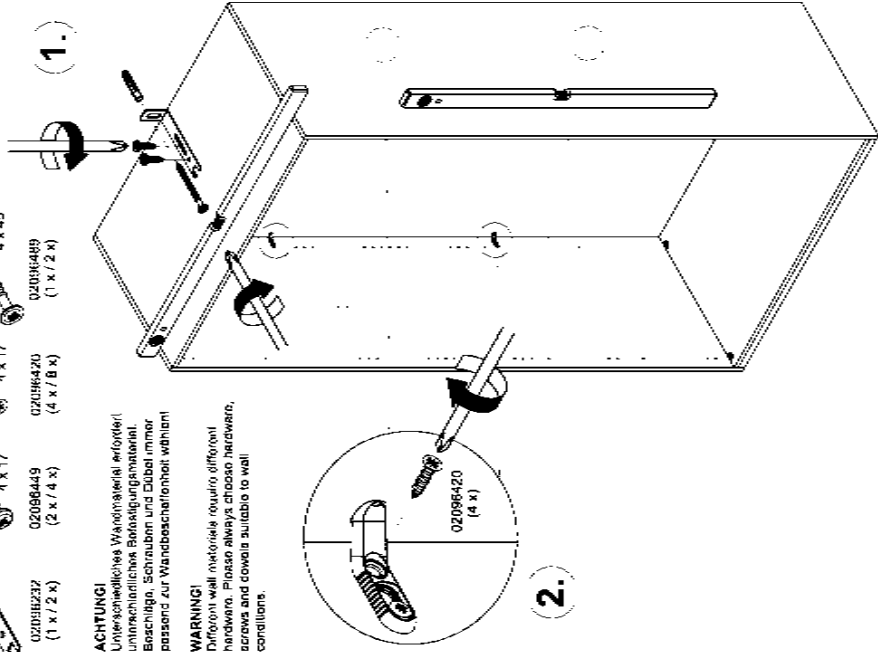
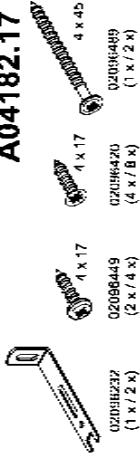
röhr**Montageanleitung
A04182.17**

ACHTUNG!
 Unterstreichen Sie die Montageanleitung
 und lesen Sie sie sorgfältig durch.
 Beachten Sie, dass die Schrauben
 passend zur Wandbeschaffenheit wählen!

WARNING!
 Diffusei well metodska opreza difuzni
 podroci. Prosto mora strogo bezavetno
 pazovati i koristiti u skladu s uvjetima
 uporabe.

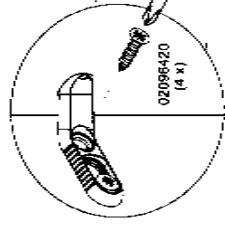
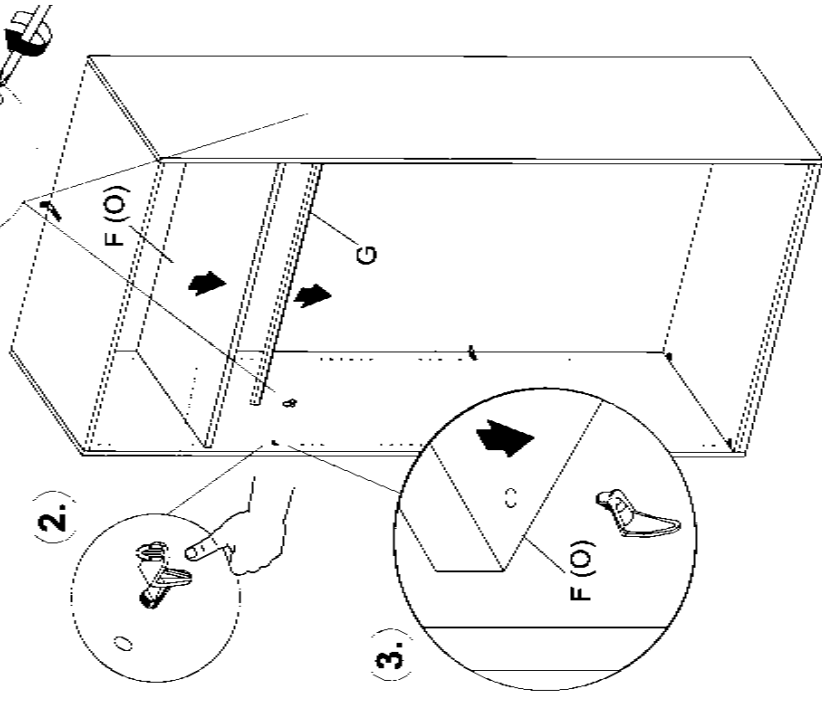
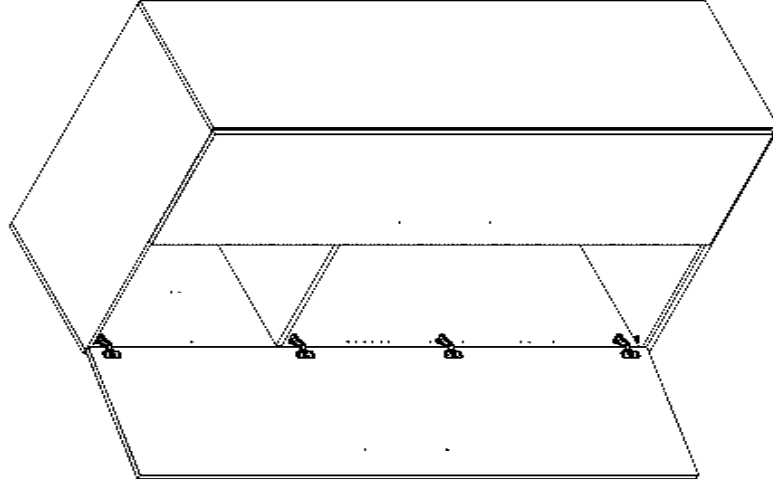
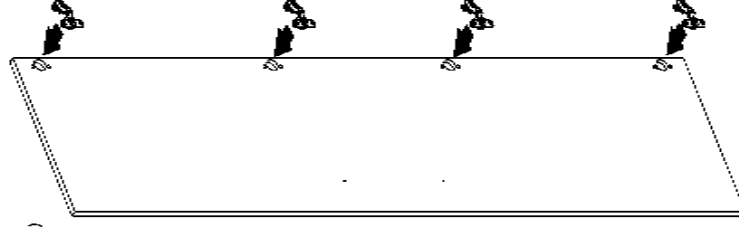
**röhr****Montageanleitung
A04182.18****röhr****Montageanleitung
A04182.19****röhr****Montageanleitung
A04182.20**

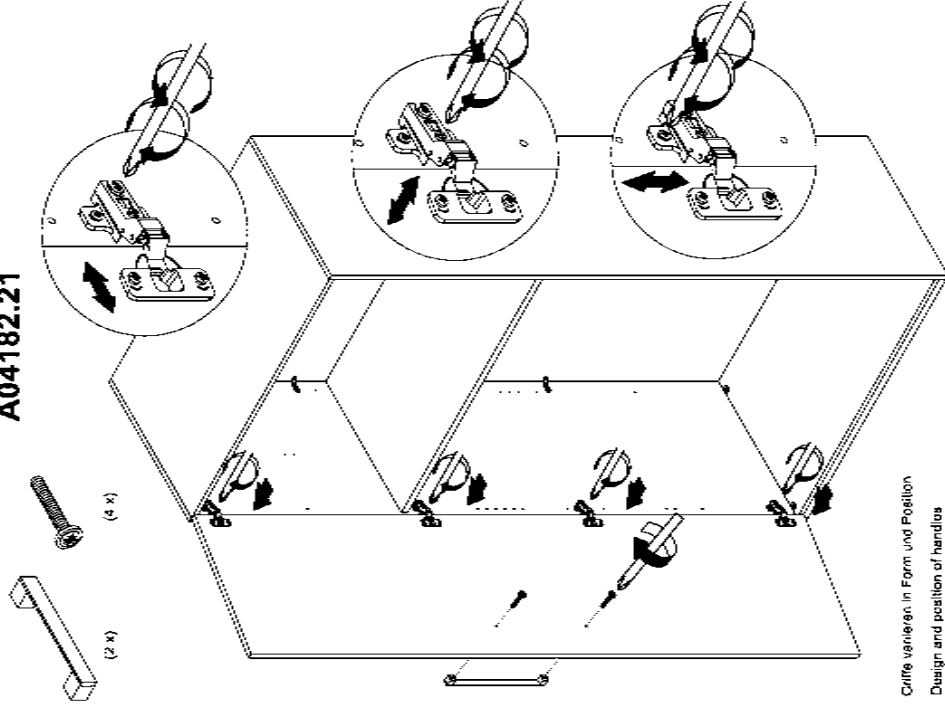

Größe variieren in Form und Position
Design and position of handles
can be different than shown

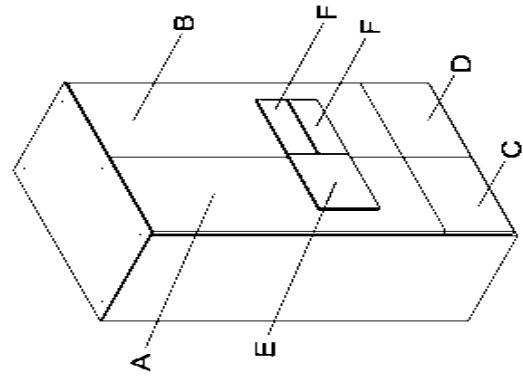

02960364



b x 30

02961846

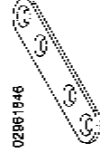

3,5 x 15

02096509



3,5 x 15

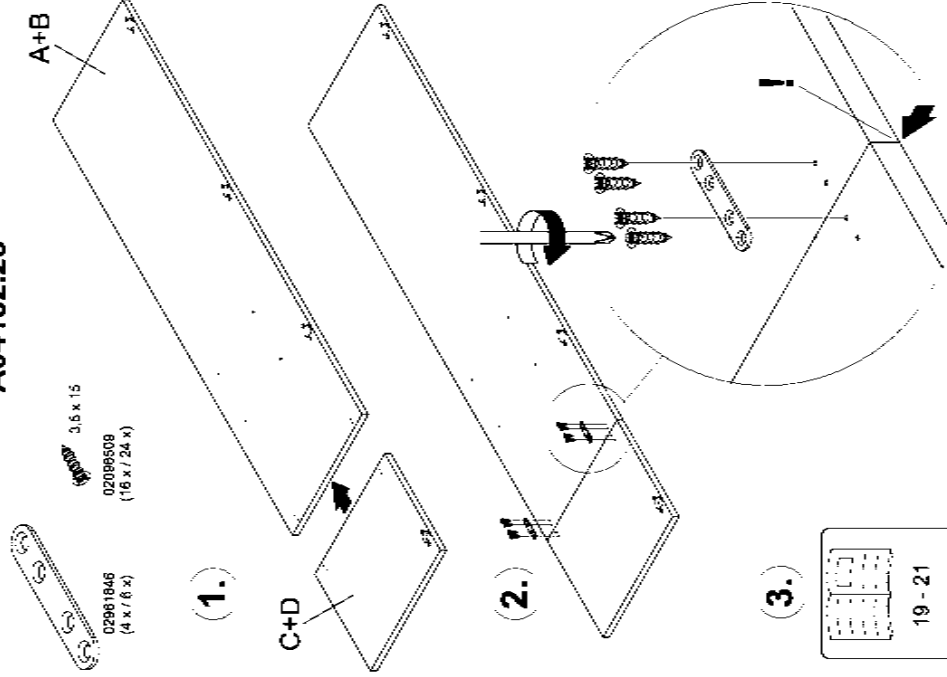
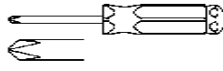

02961846

(4 x / 6 x)

02096509

(16 x / 24 x)

3,5 x 15

röhr

Montageanleitung
A04182.25

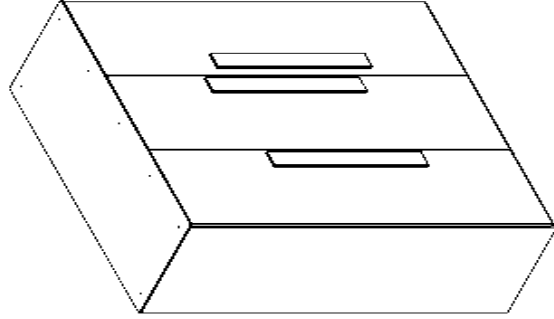

02980364 6 x 19 x



5 x 30

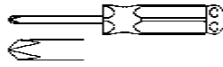

Beschlügen können aufgrund von standardisierten
Produktionsprozessen einen Überschuss an Beschlügen
enthalten.
In some of fittings maybe higher than listed because of
universal fitting "schlagel"

röhr

Montageanleitung
A04182.26

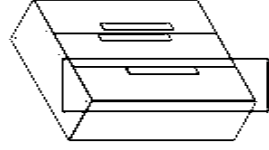

5 x 30

02980364
(3 x)

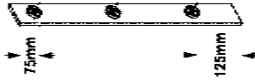
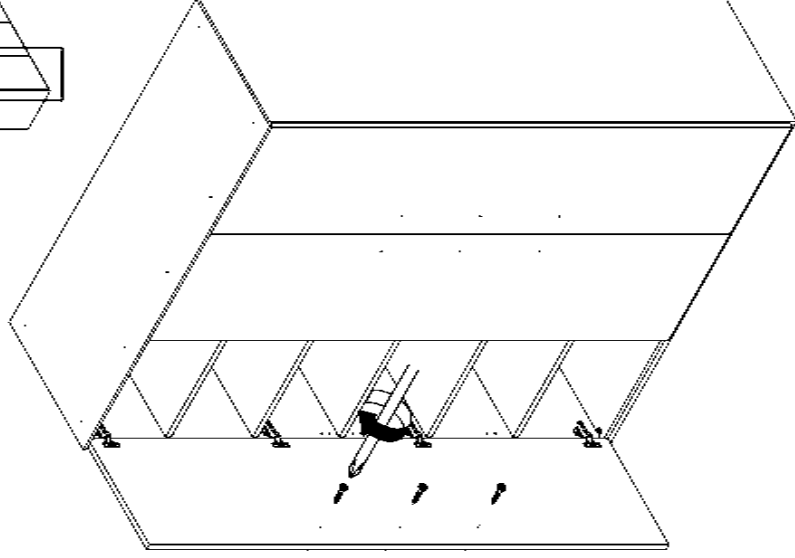

75mm

125mm

röhr

Montageanleitung
A04182.27

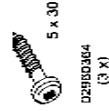
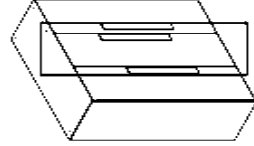

5 x 30

02980364
(3 x)

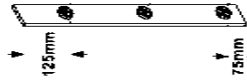
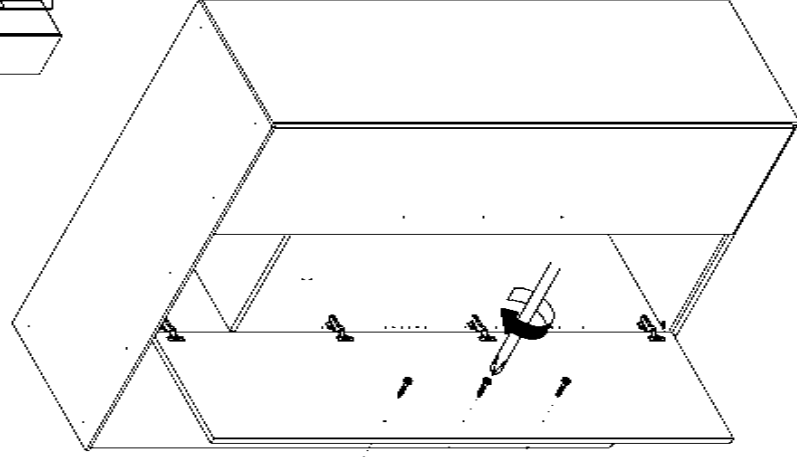

125mm

75mm

röhr

Montageanleitung
A04182.28

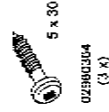
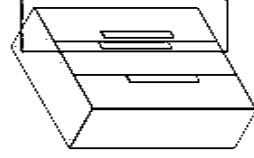

5 x 30

02980364
(3 x)

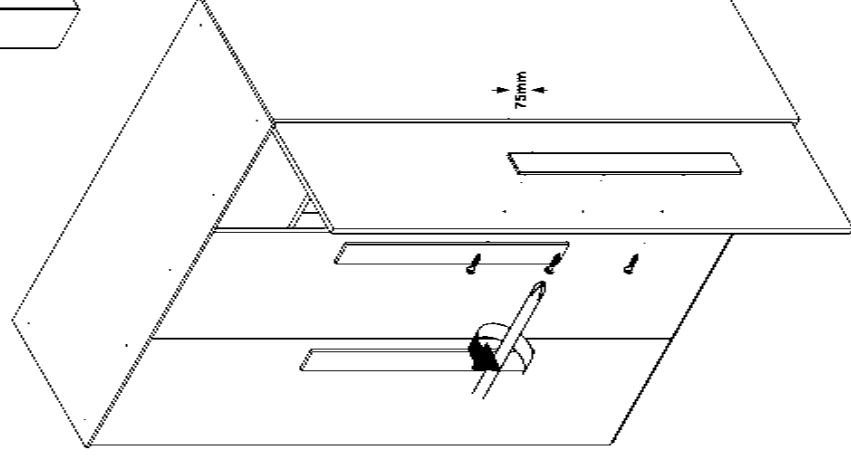

75mm

röhr

Röhr-Rush GmbH & Co. KG
 Dammstraße 32
 33397 Knetberg
 Germany
 Fon: +49 (0) 2944 981 198
 Fax: +49 (0) 2944 981 310

Montageanleitung A04185.01

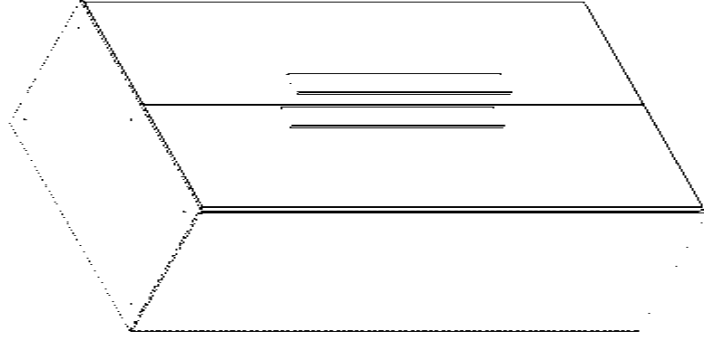

Bitte unbedingt lesen: Bei Nichtbeachtung können wir keine Gewährleistung übernehmen!
 Bitte bewahren Sie diese Montageanleitung für die Produkturkennung (Produktsicherheitsgesetz) und für event. spätere Rückfragen (wie z.B. Demontage) auf.
 Bei Weitergabe bzw. Übergabe des Artikels übernehmen Sie auch diese Montageanweisung.
 Attention! It is essential to read this. In case of non-compliance, we can not accept any liability.
 Please retain these assembly instructions for product identification and all future references i.e. disassembly.

With all transfers or deliveries of this item these assembly instructions should always be forwarded.
 D060619

röhr

Montageanleitung A04185.02

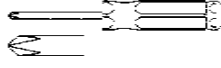
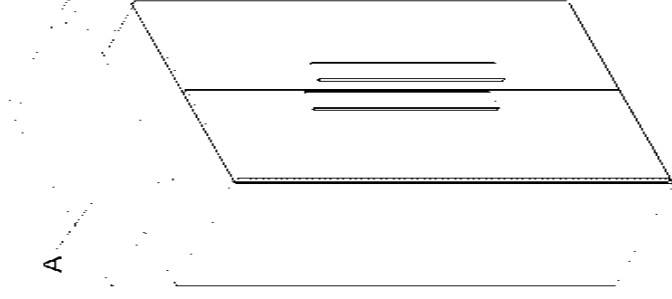

Beschädigungen können aufgrund von unrichtigen
 Produktionsprozessen oder Überschreitung der
 Tragfähigkeit von Elementen höher than listed because of
 universal 'Hilfsprodukte'!

röhr

Montageanleitung A04185.03

