

Variante A

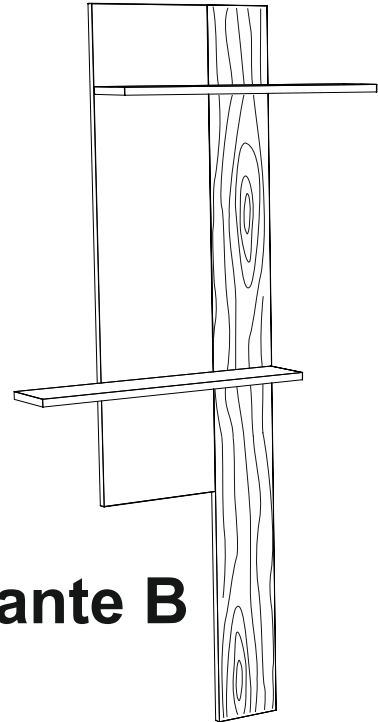

Variante B

Artikel.-Nr.:

6020-WB-00

Montageanleitung.-Nr.:

MA1-00782

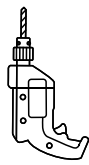
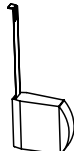
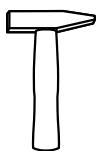
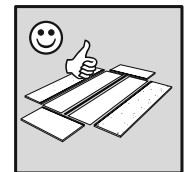
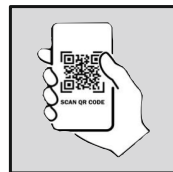
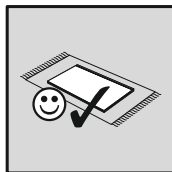
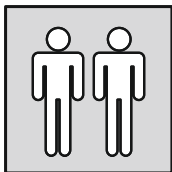
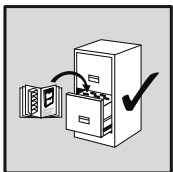





L = 20 mm

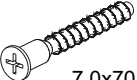

Das Ersatzteil-Anforderungsformular finden Sie auf
The replacement parts requisition form you find on
<https://www.mausbacher.de/ersatzteile/>

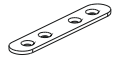
BT1-00865

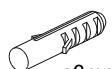
B01-20		B01-80		B02-143		B02-165		B08-30		B08-70	
6x	7,0x70	20x	3,5x13	5x		6x	30x2	2x	5,5x55	2x	ø8mm

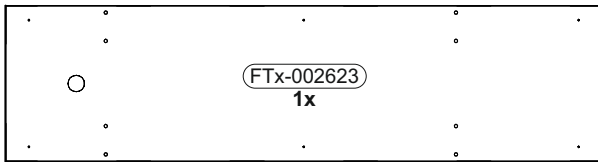

1263 x 330

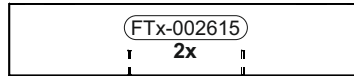

748 x 152

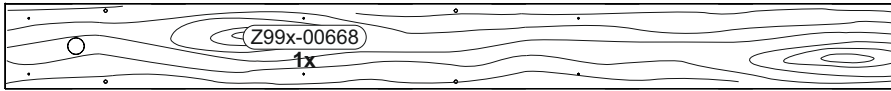

1891 x 180

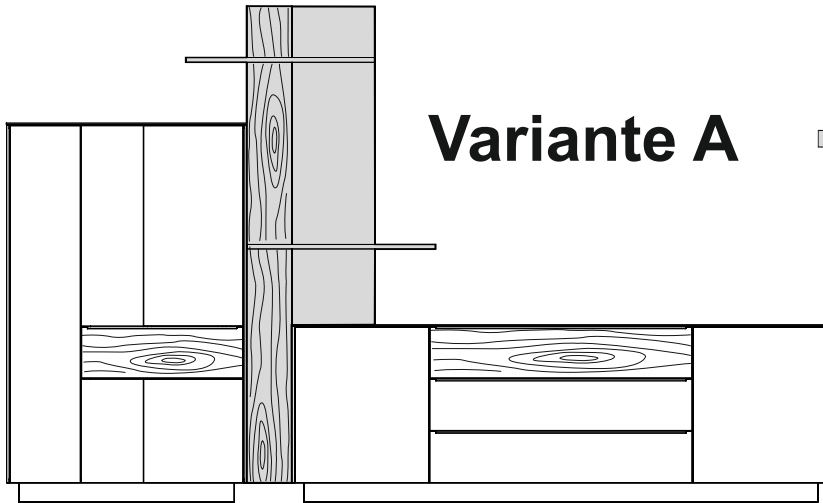

Variante A

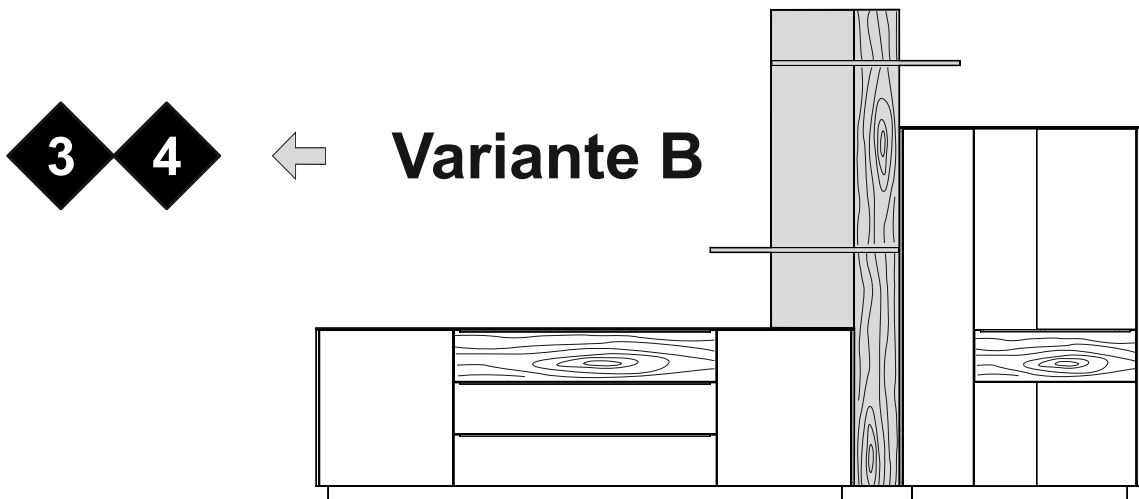

Variante B

1

	6x	20x	5x	5x	6x	30x2
		7,0x70				

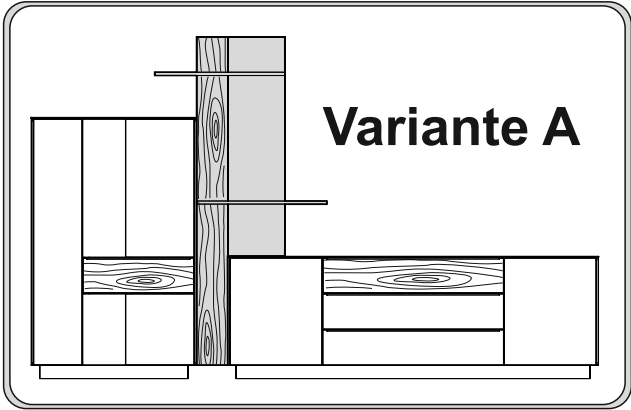
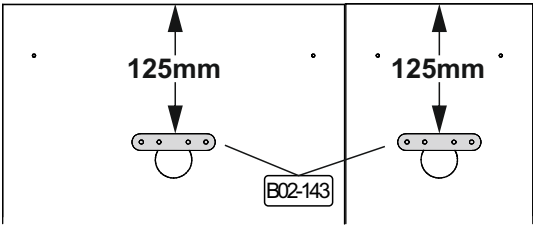

1

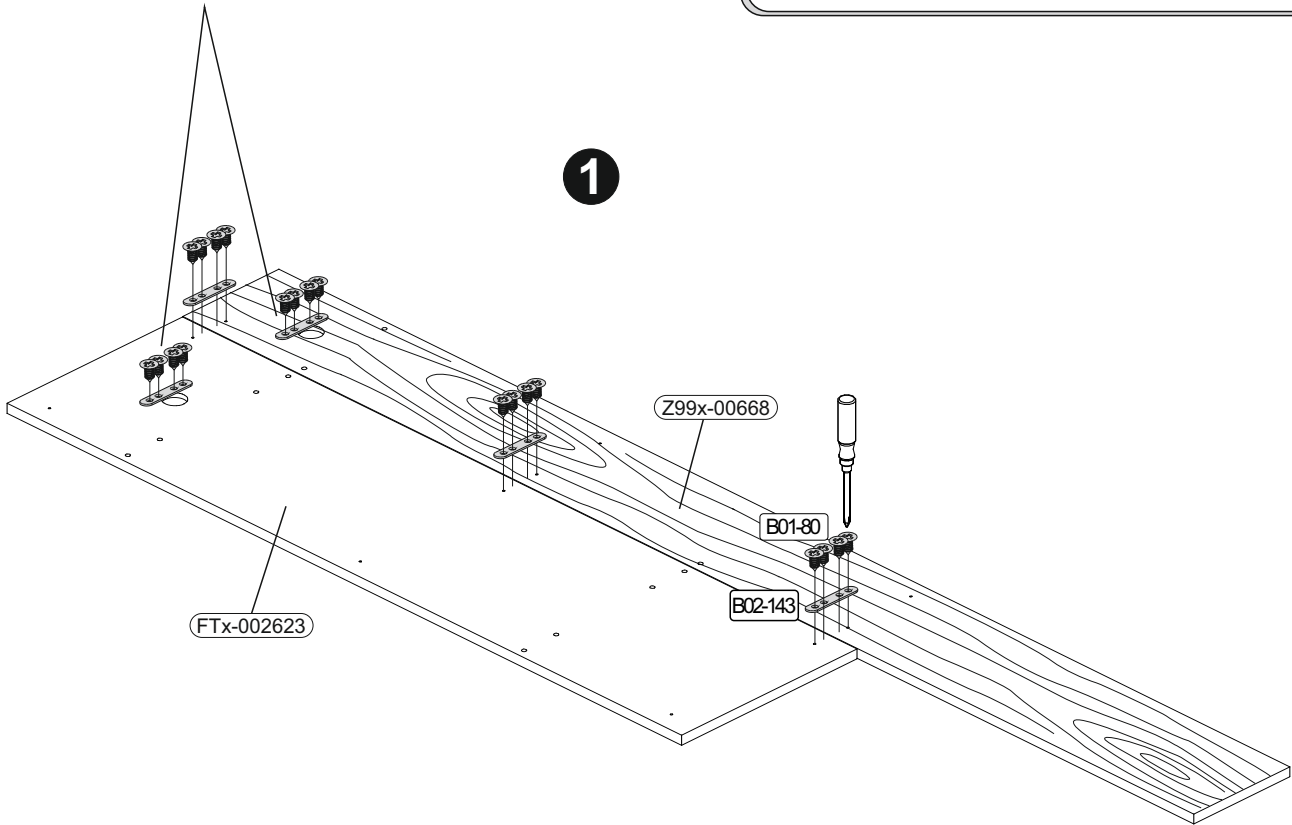

2

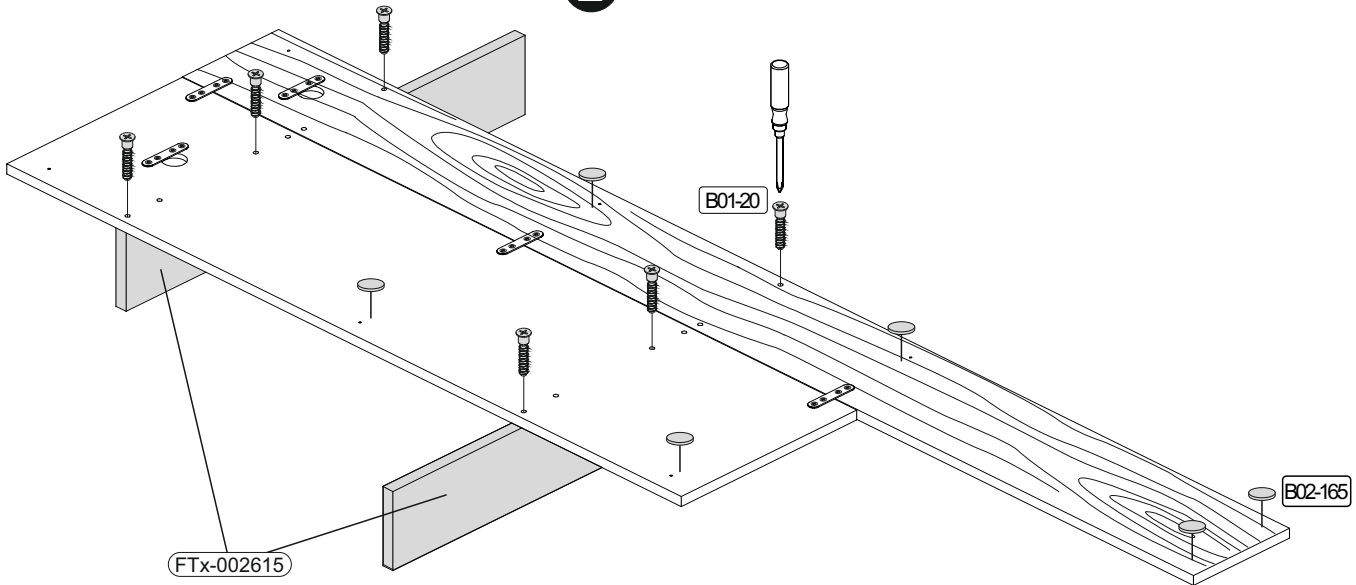

2

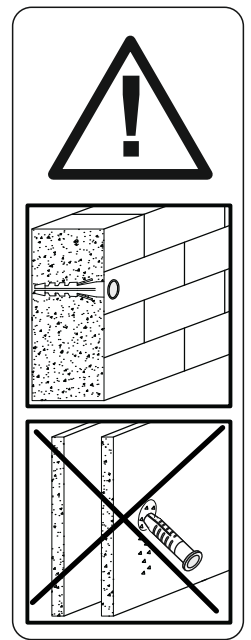
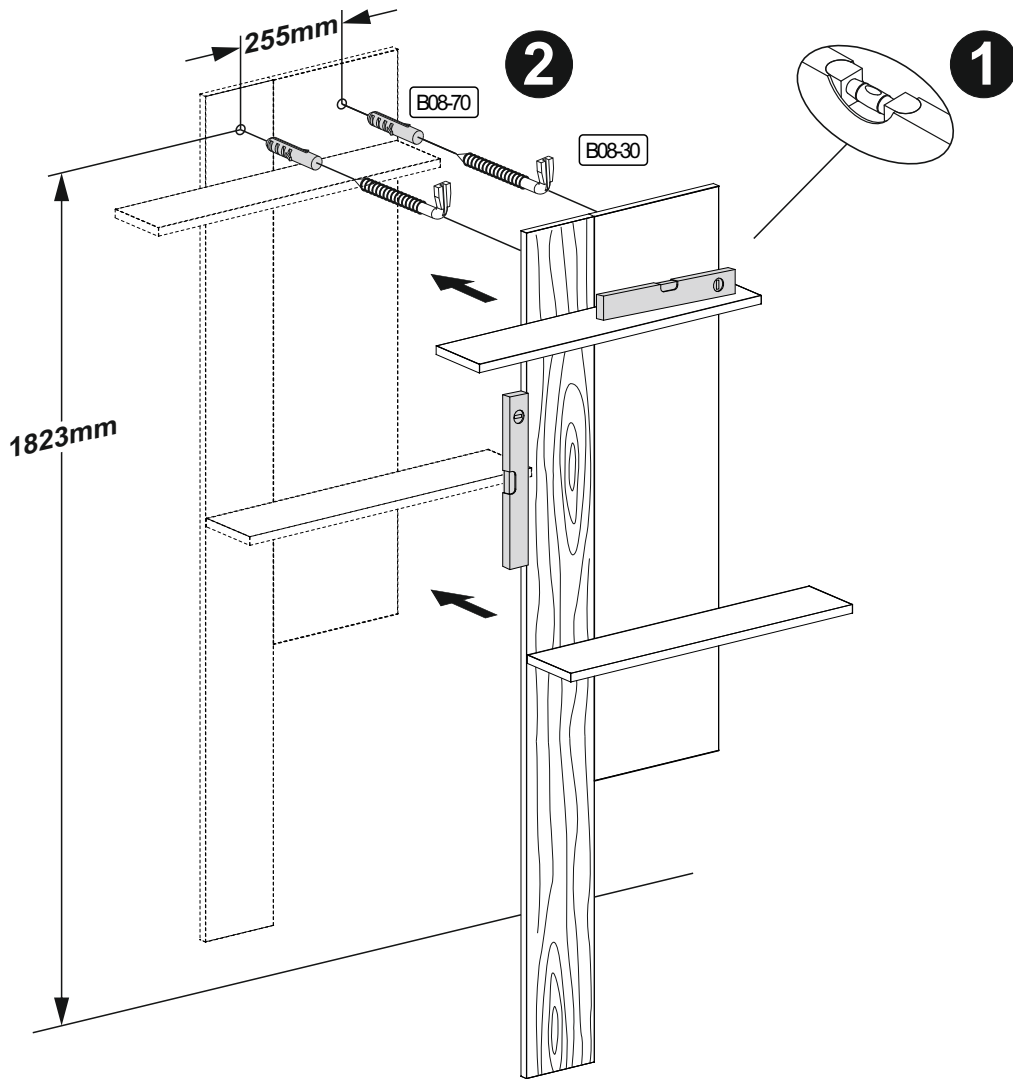
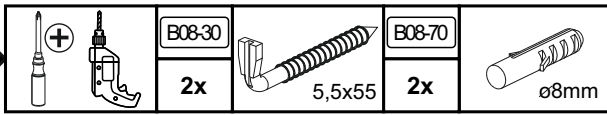

Achtung • Attention • Attenzione • Opgelet • Uwaga • Pozor • Figelem • Atenție • Dikkat • Внимание • Fara • Vaara • Fare • Peligro	
(D)	Wandbefestigung dient als Kippschutz - unbedingt anbringen! Bei einigen Wandtypen kann ein Spezialdübel erforderlich sein!
(GB)	The wall fastening serves to prevent tipping - be absolutely sure to mount it! For certain wall types, a special wall plug may be necessary!
(FR)	La fixation murale sert de protection contre le basculement – à installer impérativement ! Pour certains types de murs il faut des chevilles spéciales !
(TR)	Duvardaki sabitleme, devrilmeye karşı bir emniyet tedbiridir ve mutlaka monte edilmelidir! Bazı duvar tiplerinde bunun için özel bir dübel gerekli olabilir!
(IT)	Il fissaggio alla parete serve da protezione anti-ribaltamento – attaccarla assolutamente! Per alcune strutture di parete può essere necessario un tassello speciale!
(NL)	Bevestiging aan de muur dient als kantelbescherming – zeker en vast bevestigen! Bij enkele muurtypes is een speciale plug misschien vereist!
(RU)	Обязательно установите крепление на стене во избежание опрокидывания! Для некоторых типов стен может потребоваться специальный дюбель!
(CZ)	Montáž na stěnu slouží jako ochrana proti převrnutí – bezpodmínečně umístěte! U některých typů stěn může být zapotřebí speciální hmoždinka!
(HU)	A terméket a falhoz kel rögzíteni, különben az felborulhat! Egyes faltípusoknál speciális tiplit kell használni!
(RO)	Sistemul de fixare la perete servește ca protecție la răsturnare - de montat obligatoriu! Pentru unele tipuri de pereți este posibil să fie necesar un diblu special!
(PL)	Mocowanie do ściany jest jednocześnie zabezpieczeniem przed przewróceniem – koniecznie zamontować! Do niektórych rodzajów ścian koniecznie zastosować specjalne kołki mocujące.
(SWE)	Väggmontering fungerar som anti-lutningskydd - det är viktigt att fästa det! En speciell plugg kan behövas för vissa väggtyper!
(FIN)	Seinäkiinnitys toimii kaatumista estävänä suojana - se on ehdottomasti kiinnitettävä! Joihinkin seinätyypeihin voidaan tarvita erityistappi!
(NOR)	Veggmontering fungerer som anti-vippebeskyttelse - det er viktig å feste det! En spesiell dyvel kan være nødvendig for noen veggtyper!
(DAN)	Væggmontering fungerer som anti-vip beskyttelse - det er vigtigt at fastgøre det! En speciel dyvel kan være påkrævet til nogle vægtyper!
(SK)	Upevnenie na stenu slúži ako ochrana proti prevráteniu – bezpodmienečne použite! Pre niektoré druhy stien môže byť potrebná špeciálna hmoždinka!
(ES)	El montaje en la pared sirve como protección antivuelco: ¡es imprescindible fijarlo! ¡Es posible que se requiera una espiga especial para algunos tipos de paredes!

3

	6x	20x	5x	6x	6x	30x2
		7,0x70				

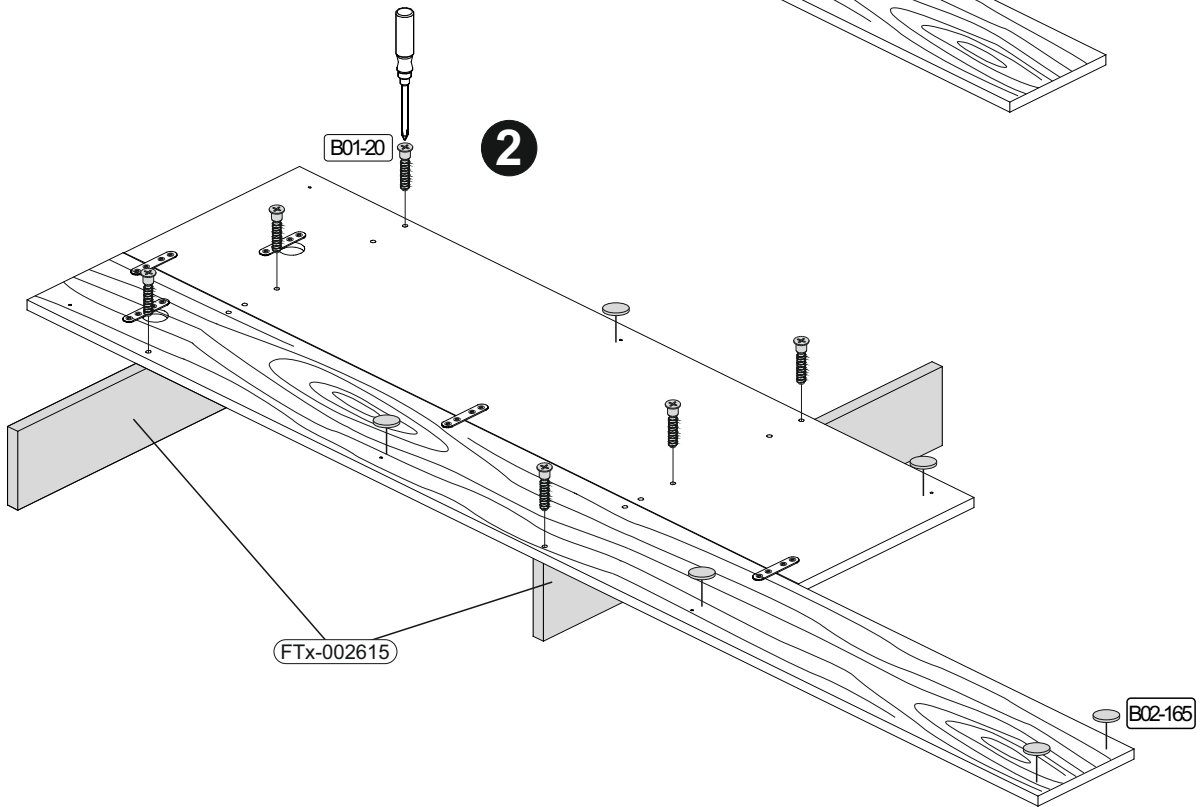
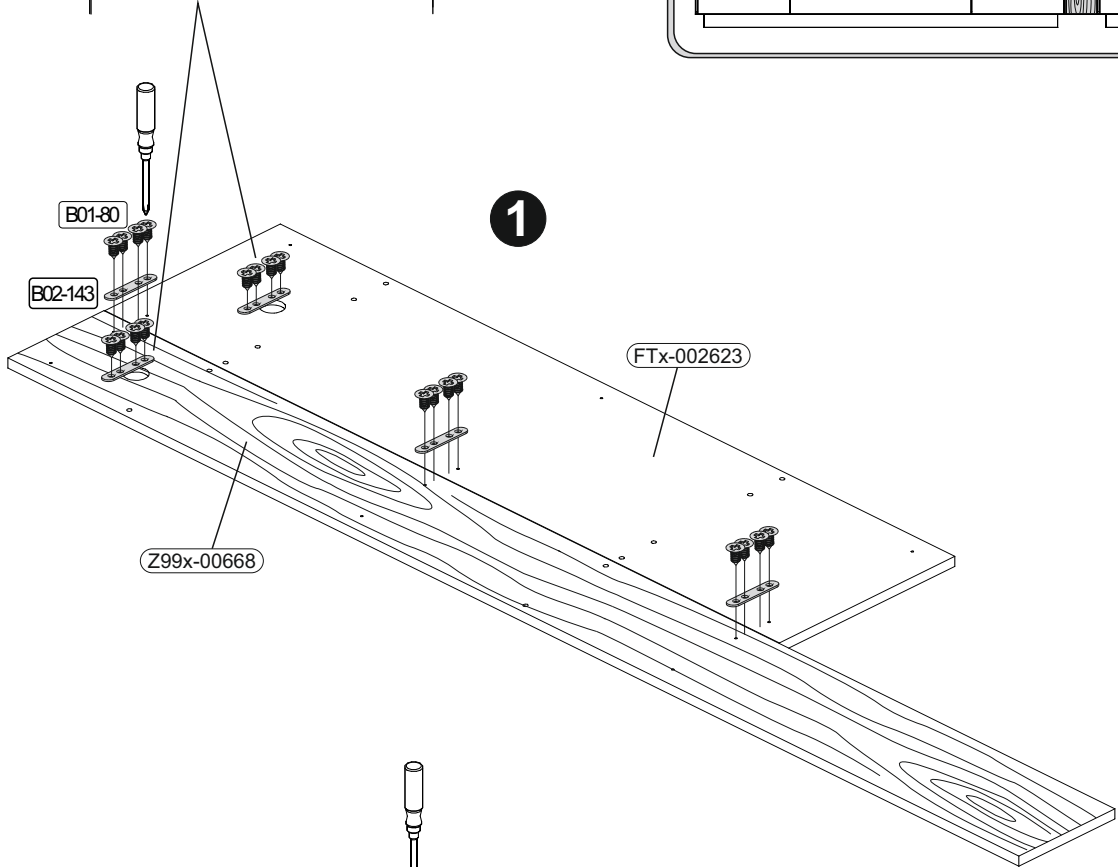
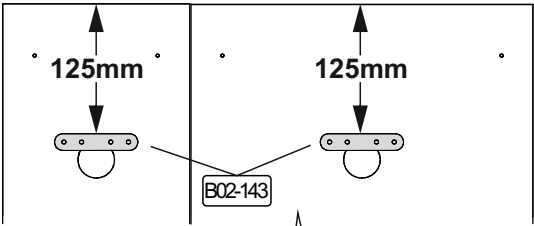
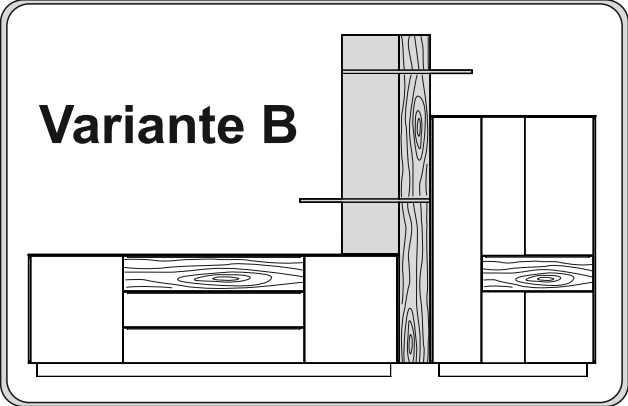

4

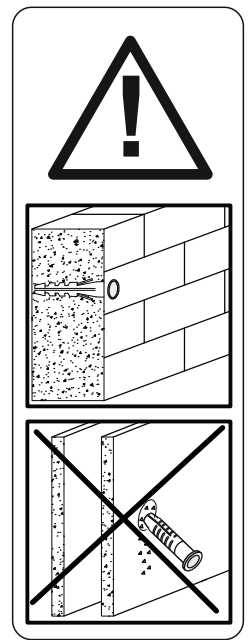
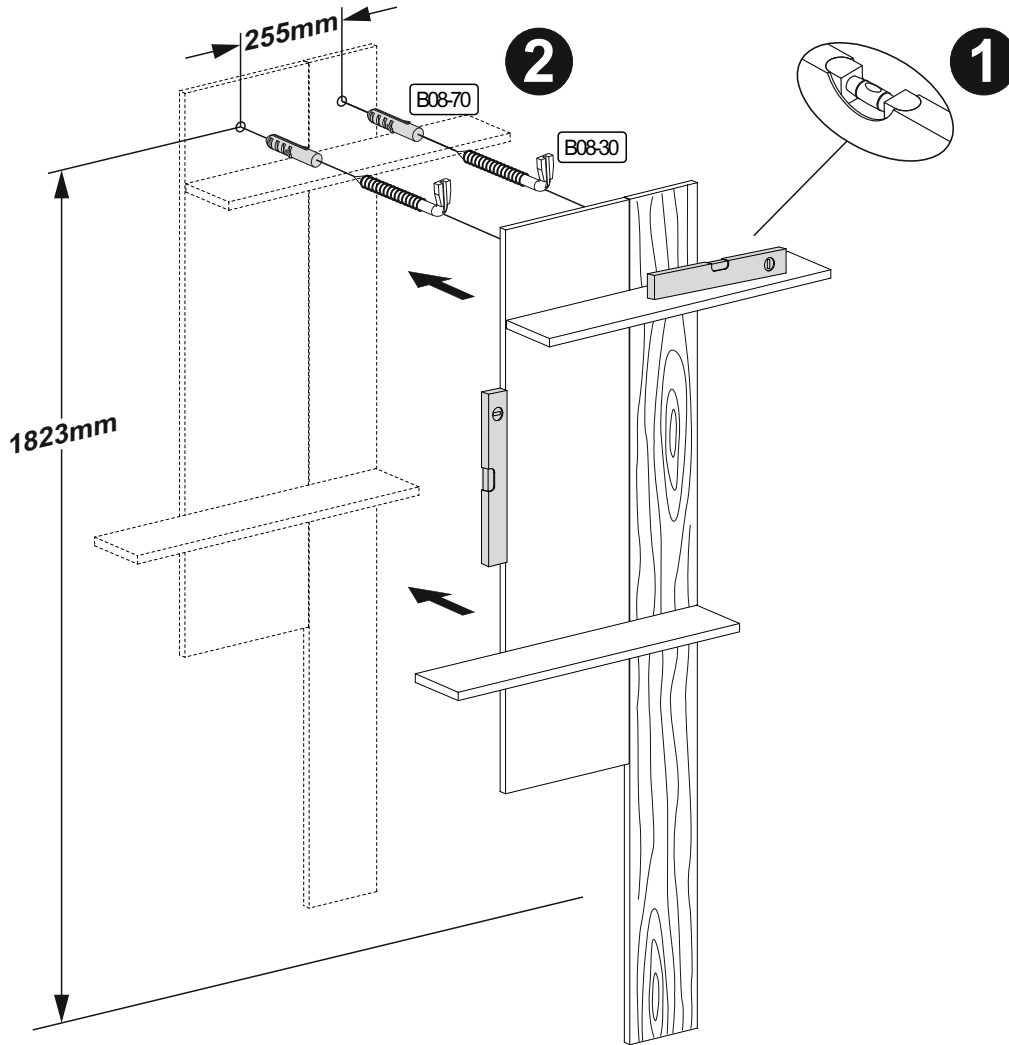
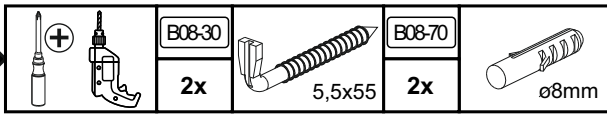

Achtung • Attention • Attenzione • Opgelet • Uwaga • Pozor • Figelem • Atenție • Dikkat • Внимание • Fara • Vaara • Fare • Peligro	
(D)	Wandbefestigung dient als Kippschutz - unbedingt anbringen! Bei einigen Wandtypen kann ein Spezialdübel erforderlich sein!
(GB)	The wall fastening serves to prevent tipping - be absolutely sure to mount it! For certain wall types, a special wall plug may be necessary!
(FR)	La fixation murale sert de protection contre le basculement – à installer impérativement ! Pour certains types de murs il faut des chevilles spéciales !
(TR)	Duvardaki sabitleme, devrilmeye karşı bir emniyet tedbiridir ve mutlaka monte edilmelidir! Bazı duvar tiplerinde bunun için özel bir dübel gerekli olabilir!
(IT)	Il fissaggio alla parete serve da protezione anti-ribaltamento – attaccarla assolutamente! Per alcune strutture di parete può essere necessario un tassello speciale!
(NL)	Bevestiging aan de muur dient als kantelbescherming – zeker en vast bevestigen! Bij enkele muurtypes is een speciale plug misschien vereist!
(RU)	Обязательно установите крепление на стене во избежание опрокидывания! Для некоторых типов стен может потребоваться специальный дюбель!
(CZ)	Montáž na stěnu slouží jako ochrana proti převrnutí – bezpodmínečně umístěte! U některých typů stěn může být zapotřebí speciální hmoždinka!
(HU)	A terméket a falhoz kel rögzíteni, különben az felborulhat! Egyes faltípusoknál speciális tiplit kell használni!
(RO)	Sistemul de fixare la perete servește ca protecție la răsturnare - de montat obligatoriu! Pentru unele tipuri de pereți este posibil să fie necesar un diblu special!
(PL)	Mocowanie do ściany jest jednocześnie zabezpieczeniem przed przewróceniem – koniecznie zamontować! Do niektórych rodzajów ścian koniecznie zastosować specjalne kołki mocujące.
(SWE)	Väggmontering fungerar som anti-lutningskydd - det är viktigt att fästa det! En speciell plugg kan behövas för vissa väggtyper!
(FIN)	Seinäkiinnitys toimii kaatumista estävänä suojana - se on ehdottomasti kiinnitettävä! Joihinkin seinätyypeihin voidaan tarvita erityistappi!
(NOR)	Veggmontering fungerer som anti-vippebeskyttelse - det er viktig å feste det! En spesiell dyvel kan være nødvendig for noen veggtyper!
(DAN)	Væggmontering fungerer som anti-vip beskyttelse - det er vigtigt at fastgøre det! En speciel dyvel kan være påkrævet til nogle vægtyper!
(SK)	Upevnenie na stenu slúži ako ochrana proti prevráteniu – bezpodmienečne použite! Pre niektoré druhy stien môže byť potrebná špeciálna hmoždinka!
(ES)	El montaje en la pared sirve como protección antivuelco: ¡es imprescindible fijarlo! ¡Es posible que se requiera una espiga especial para algunos tipos de paredes!