

**VITO TICONA
PAYTON**

D MONTAGEANLEITUNG
BEDIENUNGSANLEITUNG

NL HANDLEIDING VOOR DE MONTAGE
GEBRUIKSAANWIJZING

TR MONTAJ TALIMATI
KULLANIM KLAVUZU

RO INSTRUCȚIUNI DE INSTALARE
INSTRUCȚIUNI DE UTILIZARE

FR NOTICE DE MONTAGE
MANUEL INSTRUCTIONS

HU KÖZGYŰLÉS UTASÍTÁSOK
KEZELÉSI UTASÍTÁS

SI NAVODILA ZA MONTAŽO
NAVODILA ZA UPORABO

ES INSTRUCCIONES DE MONTAJE
MANUAL DEL USUARIO

GB ASSEMBLY INSTRUCTIONS
INSTRUCTION MANUAL

PL INSTRUKCJA MONTAŻU
INSTRUKCJA OBSŁUGI

RU ИНСТРУКЦИЯ ПО МОНТАЖУ
ИНСТРУКЦИЯ ПО ЭКСПЛУАТАЦИИ

IT ISTRUZIONI DI MONTAGGIO
MANUALE DI ISTRUZIONI

SK MONTÁŽNY NÁVOD
NÁVOD NA POUŽITIE

CZ MONTÁŽNÍ NÁVOD
NÁVOD K POUŽITÍ

PT INSTRUÇÕES DE MONTAGEM
MANUAL DO USUÁRIO

HR UPUTE ZA MONTAŽU
UPUTE ZA UPOTREBU

Service · Dienstverlening · Serwis · Servis · Сервисная служба · Serviciu · Services · Servizio · Servisný list · Szolgáltatás · Servisní list

Name · Naam · Nazwa · İsim · Название · Nume · Nome ·
Názov · Názov · Název · Neve

Тур · Туре · Tip · Тип · Típo · Típus

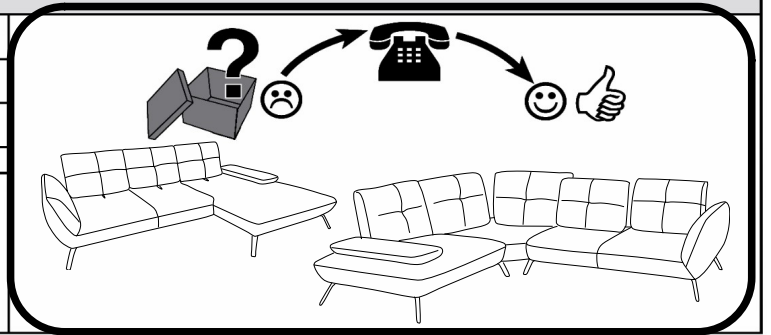
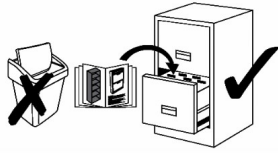

✓	Var. B		 A a1	 B M6x25	 C	 D 4L
 2er			4 x A 4 x a1	4x 3B	1C	
 2er			2 x A 2 x a1	2x 3B	1C	
 2er			4 x A 4 x a1	2x 3B + 2x 4B	1C	
 3er			4 x A 4 x a1	4x 3B	2C	1D
 3er			2 x A 2 x a1	2x 3B	2C	
 3er			4 x A 4 x a1	2x 3B + 2x 4B	2C	

✓ **Var. B**

A

B

M6x25

C

D

4L

E

5L

M8x30

a1

e1

A **A** (x3B) (x4B)

A **A** (x3B) (x4B)

4xA
4xa1

2x**3B**
+
2x**4B**

/

/

A **A** (x3B) (x3B)

A **A** (x3B) (x3B)

2xA
2xa1

2x**3B**

/

/

A **A** (x3B) (x4B)

A **A** (x3B) (x4B)

C C **C C** (x4B)

C C **C C** (x4B)

4xA
4xa1

2x**3B**
+
2x**4B**

2C

/

A **A** (x3B) (x3B)

A **A** (x3B) (x3B)

C C **C C** (x3B)

C C **C C** (x3B)

4xA
4xa1

4x**3B**

2C

/

A **A**

A **A**

C **C**

E **E**

4xA
4xa1

4x**3B**

1C

1xE
1xe1

A **A** x3B x3B

A **A** x4B x4B

C **C**

C **C**

4xA
4xa1

2x**3B**
+
2x**4B**

2C









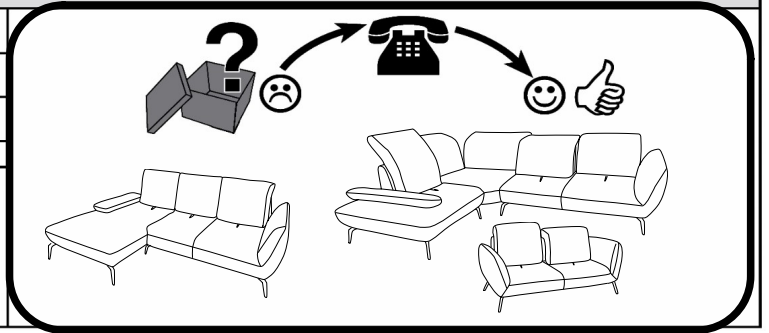
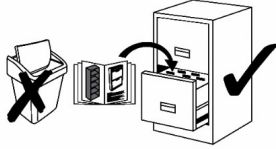

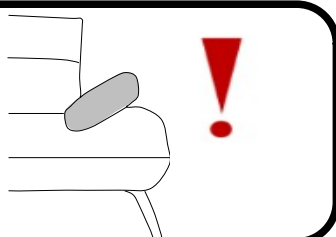

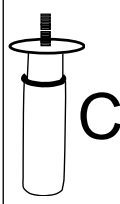
/

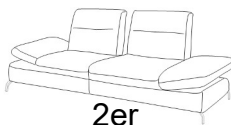
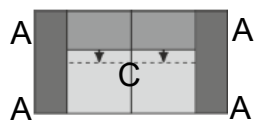
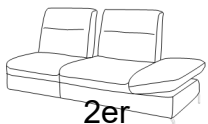
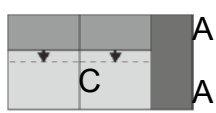
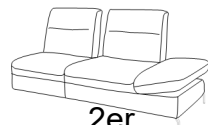
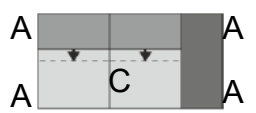
Service · Dienstverlening · Serwis · Servis · Сервисная служба · Serviciu ·
Services · Servizio · Servisný list · Szolgáltatás · Servisní list

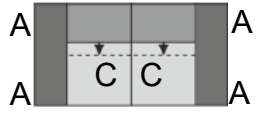
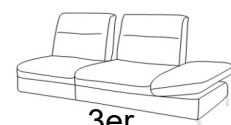
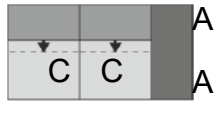
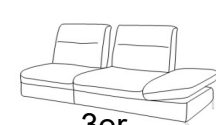
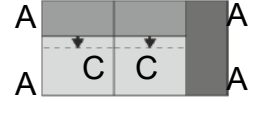
Name · Naam · Nazwa · İsim · Название · Nume · Nome ·
Názov · Názov · Název · Neve

Тур · Туре · Tip · Тип · Tiro · Típus



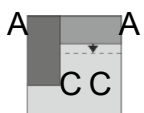







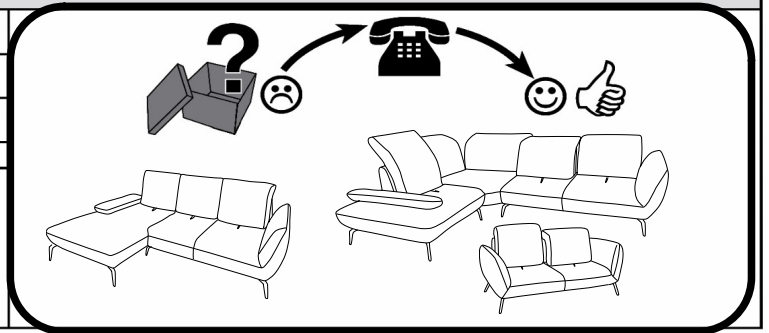
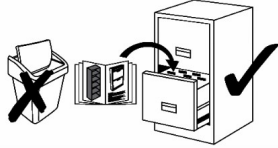

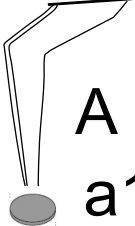
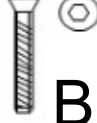
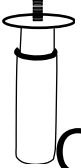



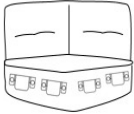

✓	Var. A		 A a1	 B M6x25	 C	 D 4L
			4 x A 4 x a1	4x4B	1C	1D
			2 x A 2 x a1	2x4B	1C	
			4 x A 4 x a1	4x4B	1C	
			4 x A 4 x a1	4x4B	2C	
			2 x A 2 x a1	2x4B	2C	
			4 x A 4 x a1	4x4B	2C	
			4 x A 4 x a1	4x4B	/	
			2 x A 2 x a1	2x4B	/	
			4 x A 4 x a1	4x4B	2C	

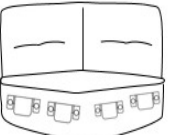
Service · Dienstverlening · Serwis · Servis · Сервисная служба · Serviciu ·
Services · Servizio · Servisný list · Szolgáltatás · Servisní list

Name · Naam · Nazwa · İsim · Название · Nume · Nome ·
Názov · Názov · Název · Neve

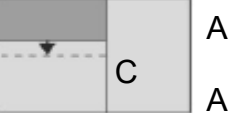
Тур · Туре · Тір · Тип · Тіро · Típus

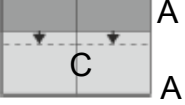

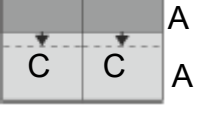
✓			 A a1	 B M6x25	 C	 D 4L	 E 5L	 F M8	 G M8x30
			4 x A 4 x a1	4x4B	/	1D			
			1 x A 1 x a1	1x4B	1C	1D	1E	4xF	4xG
			3 x A 3 x a1	3x4B	1C	1D	1E	8xF	8xG
			4 x A 4 x a1	4x4B	1C	1D			
			2 x A 2 x a1	2x4B	1C	1D			
	 2er		2 x A 2 x a1	2x4B	1C	1D			
	 3er		2 x A 2 x a1	2x4B	2C	1D			

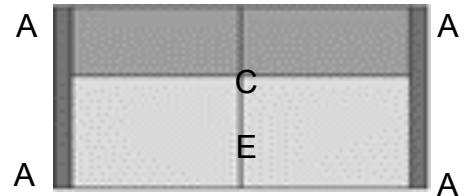
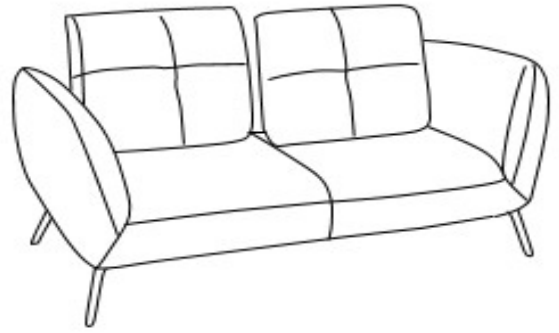
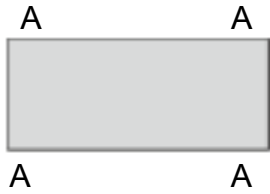
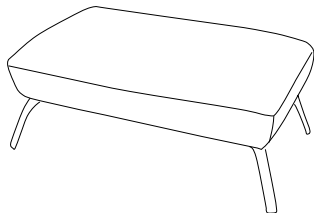

Megasofa

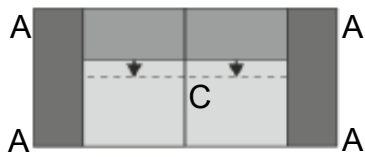
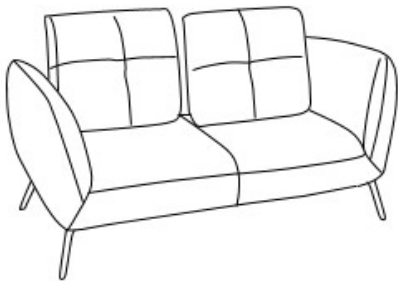

2er

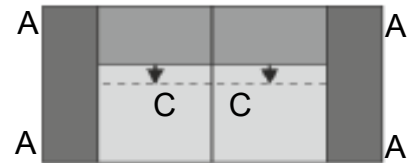
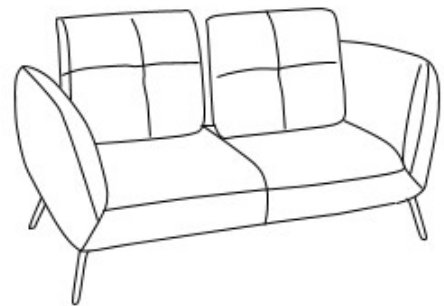

3er

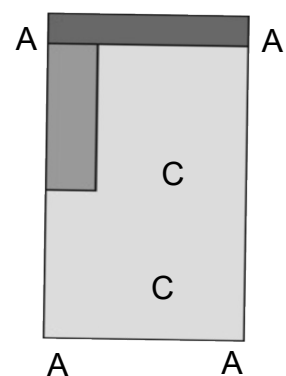
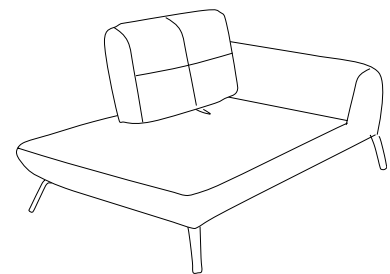
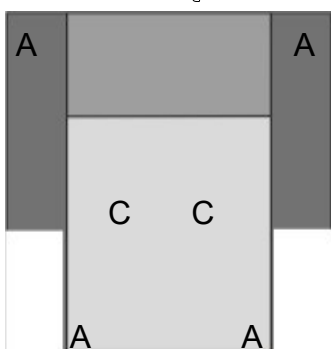
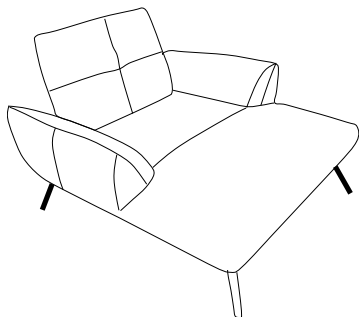

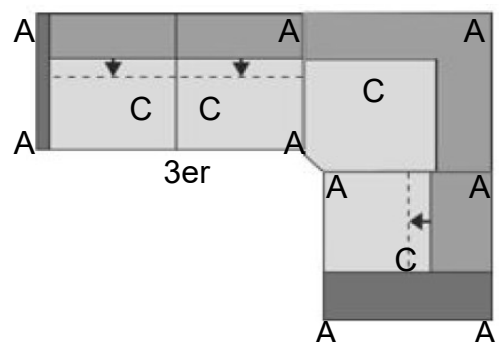
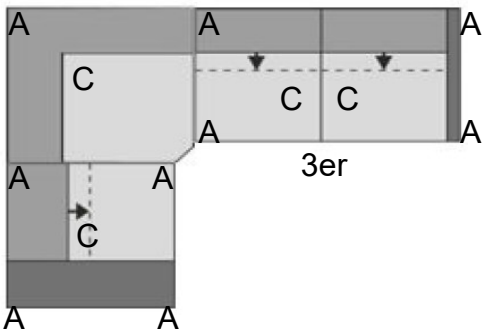
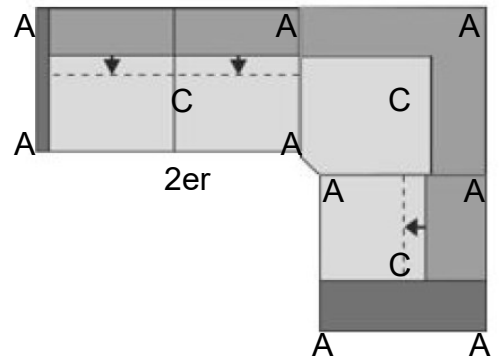
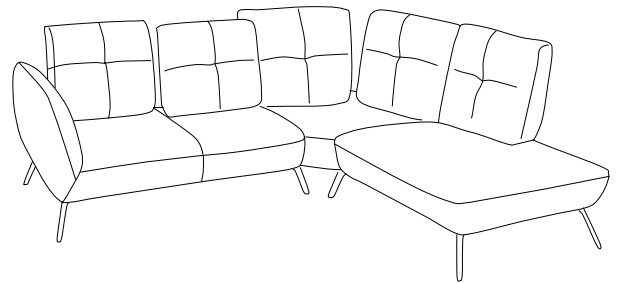
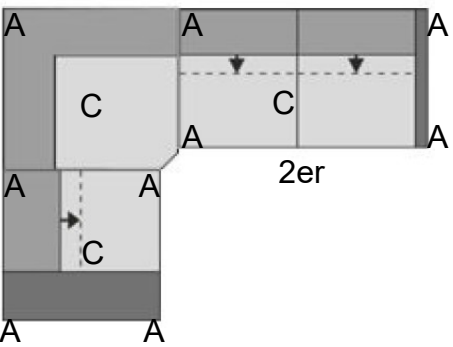
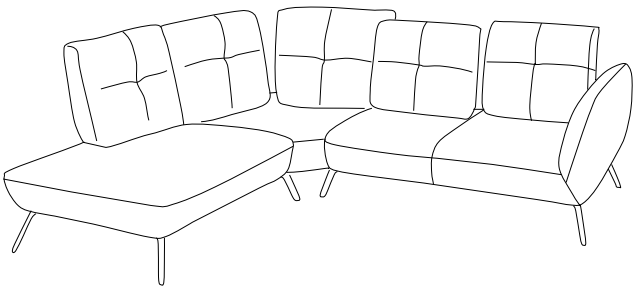
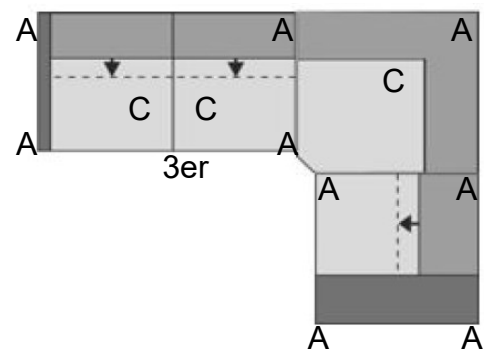
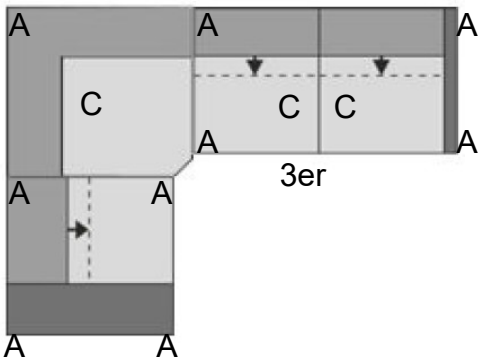
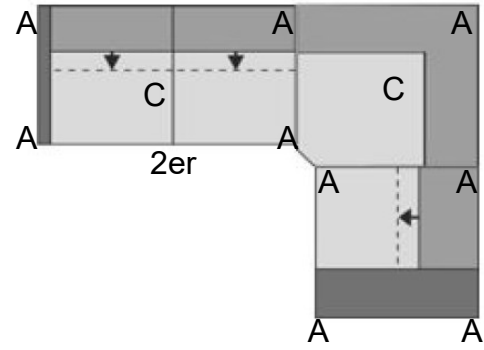
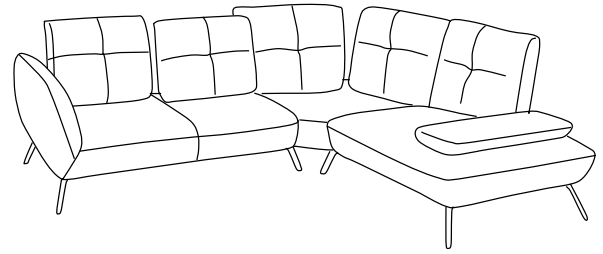
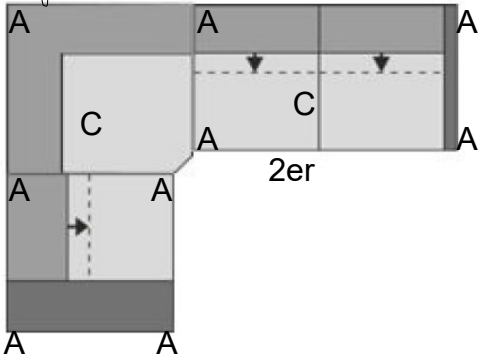
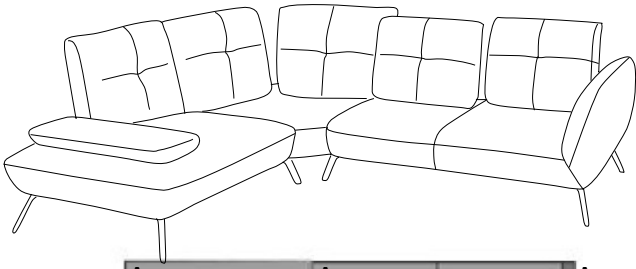

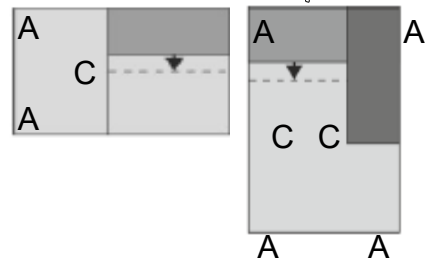
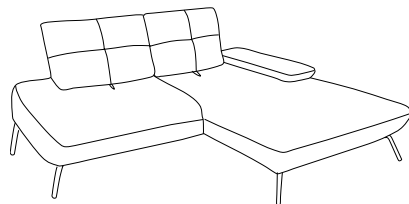
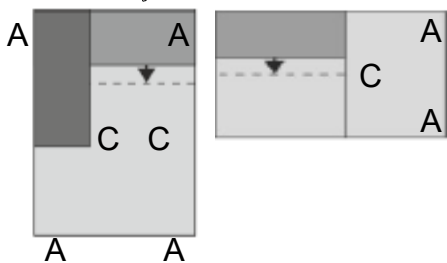
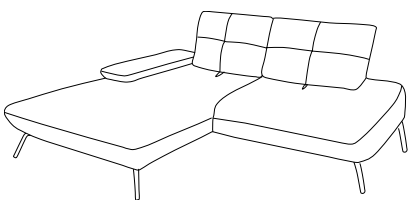
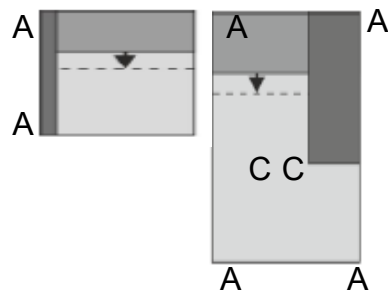
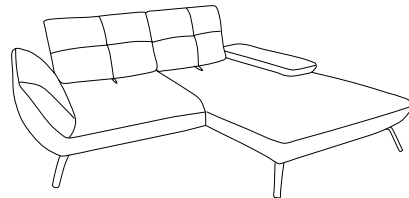
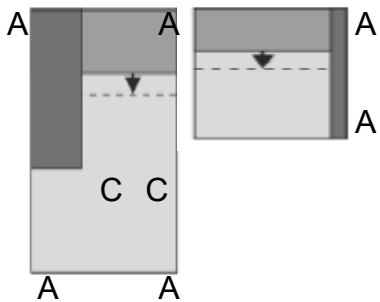
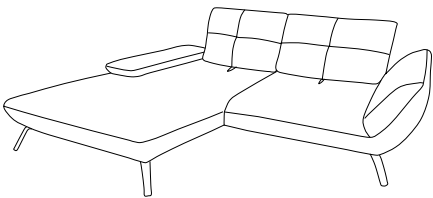
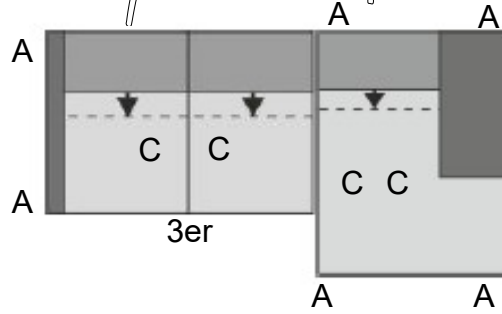
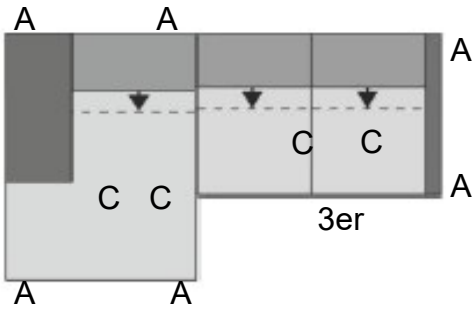
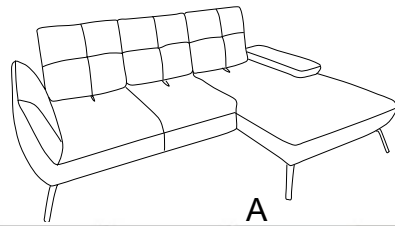
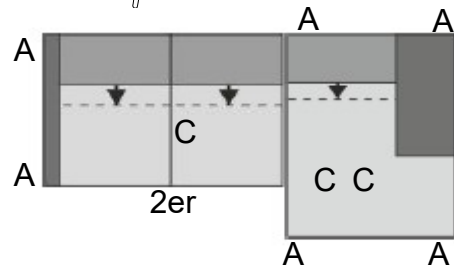
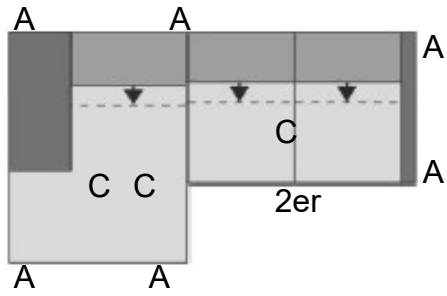
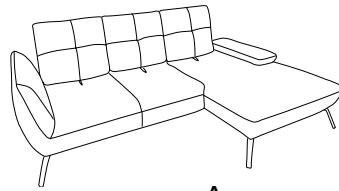

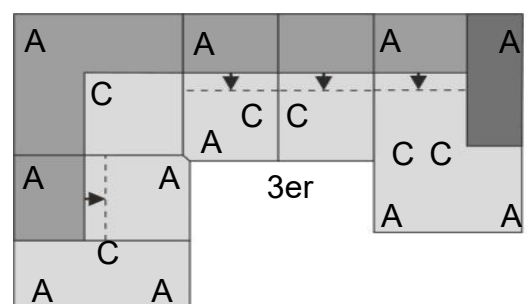
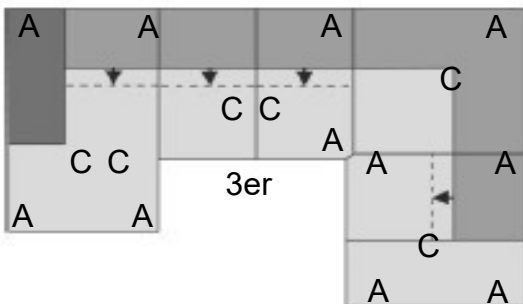
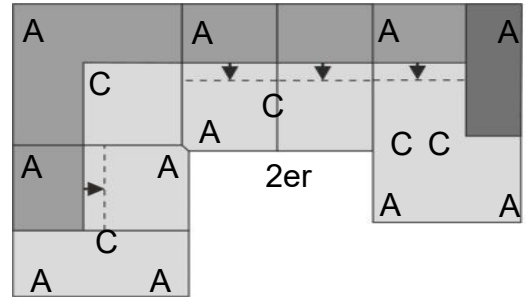
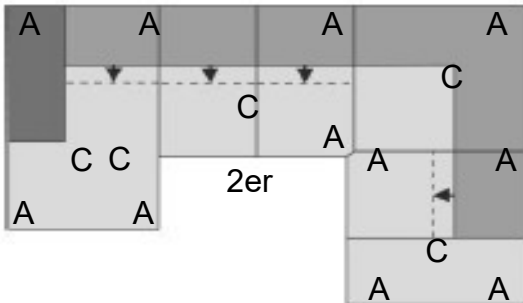
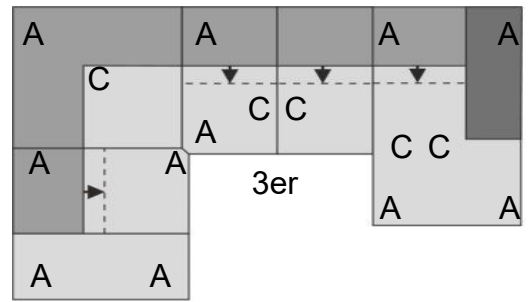
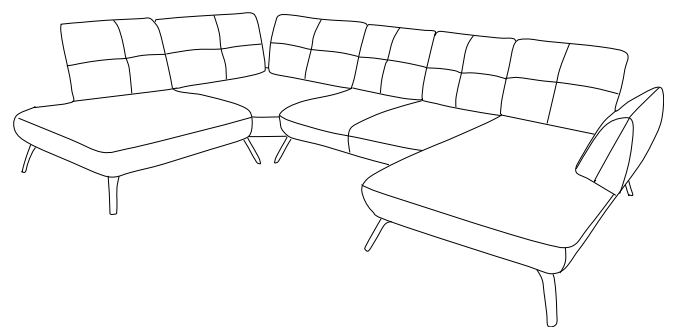
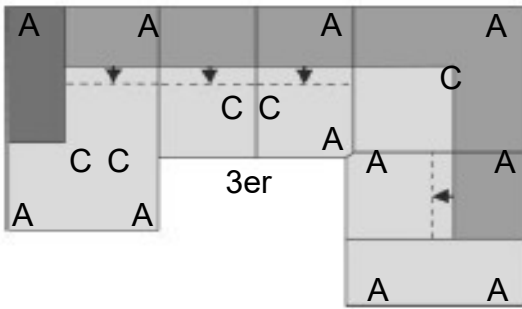
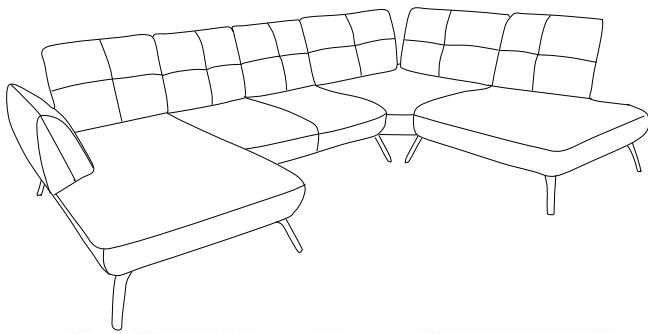
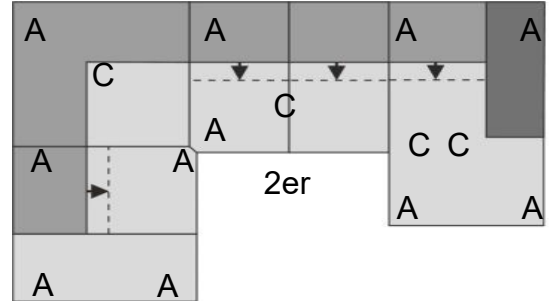
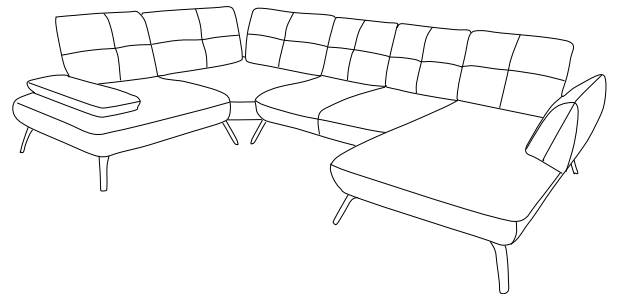
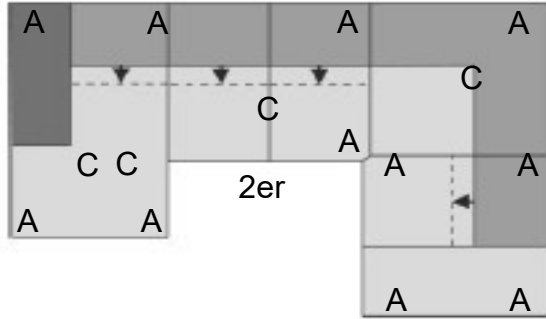
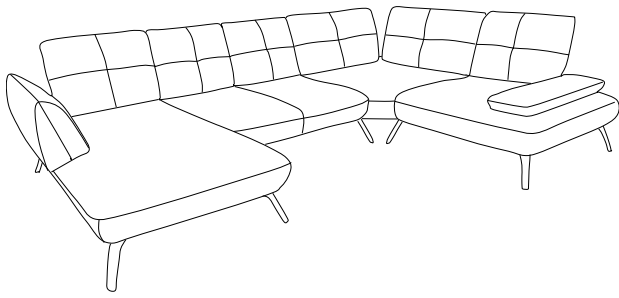

1

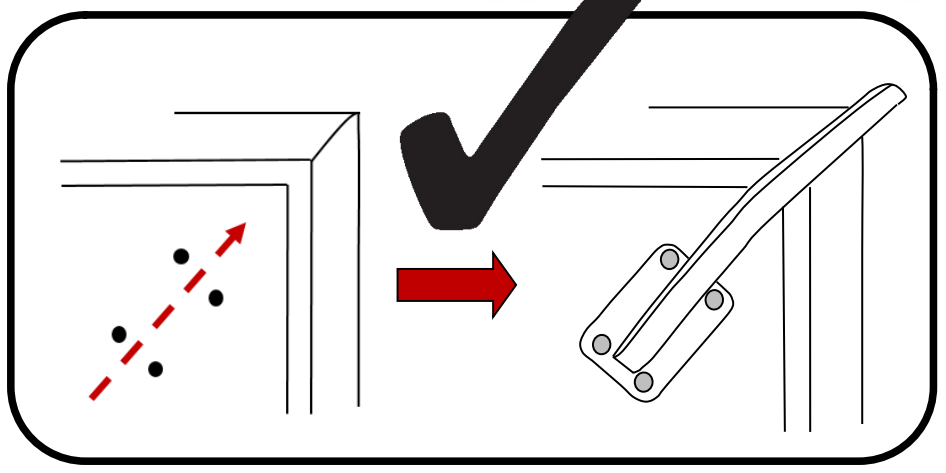
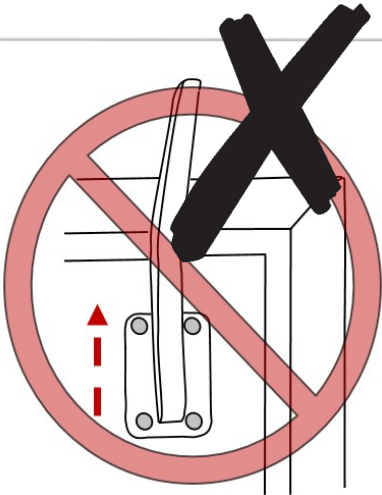
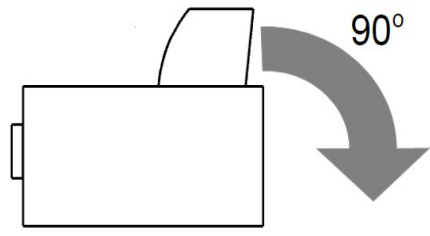

2

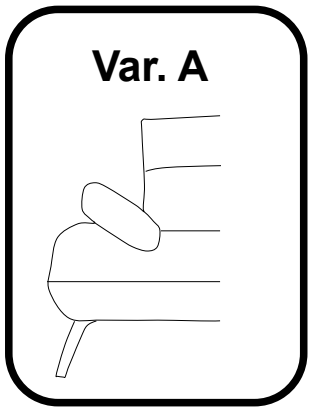

A

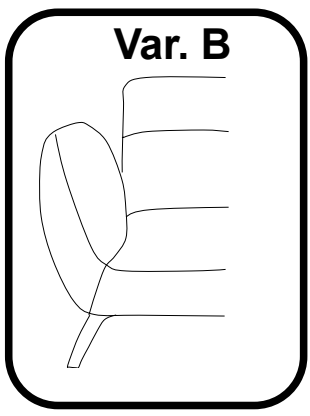
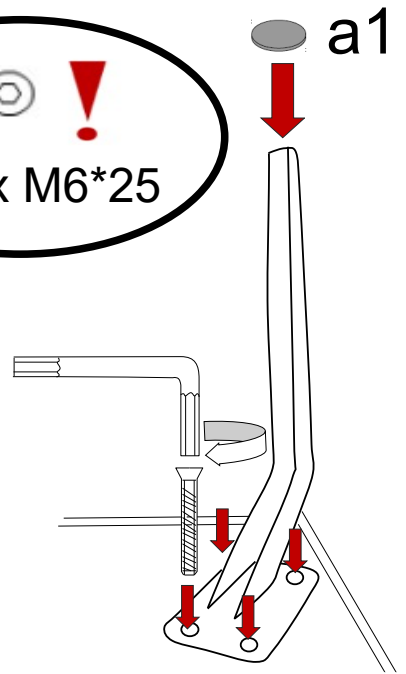
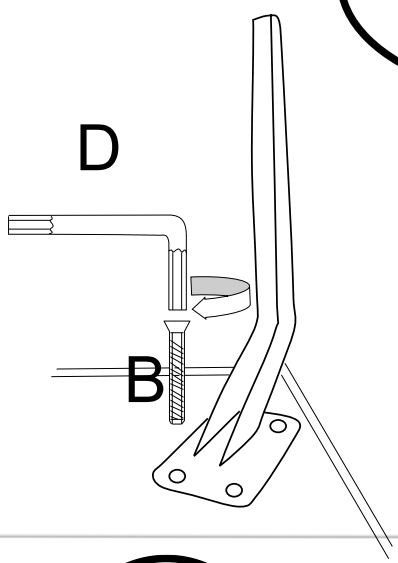
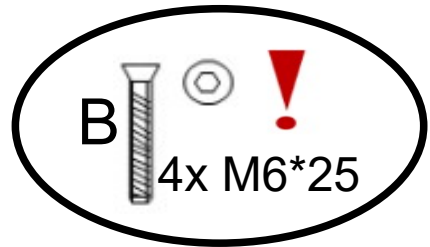

A

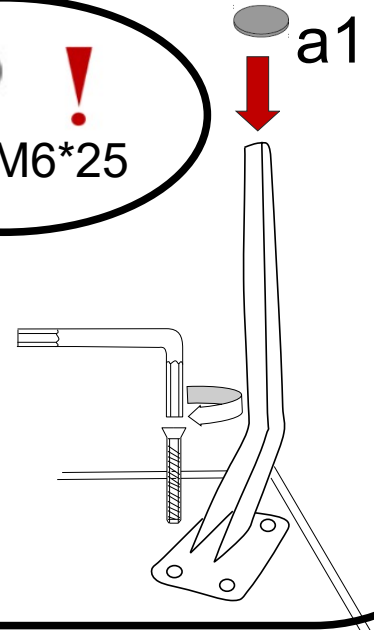
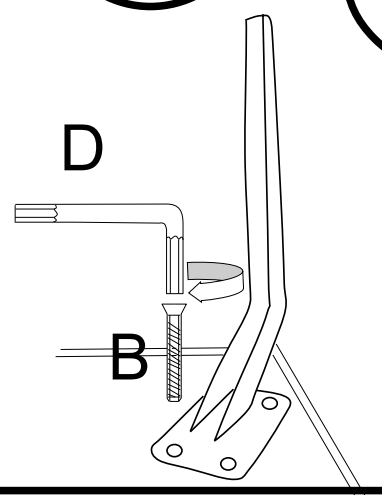
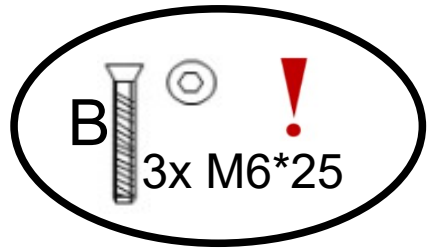

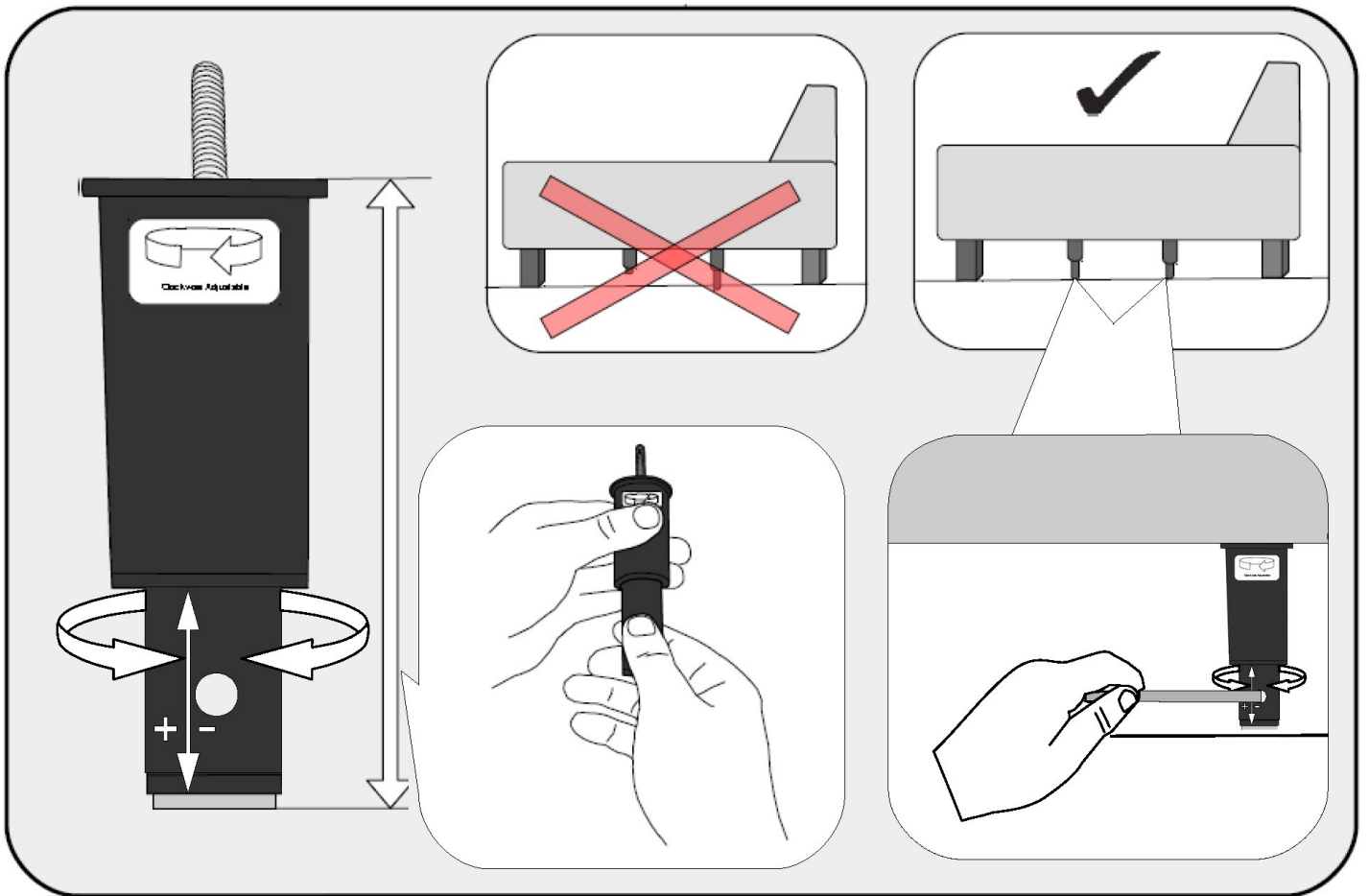
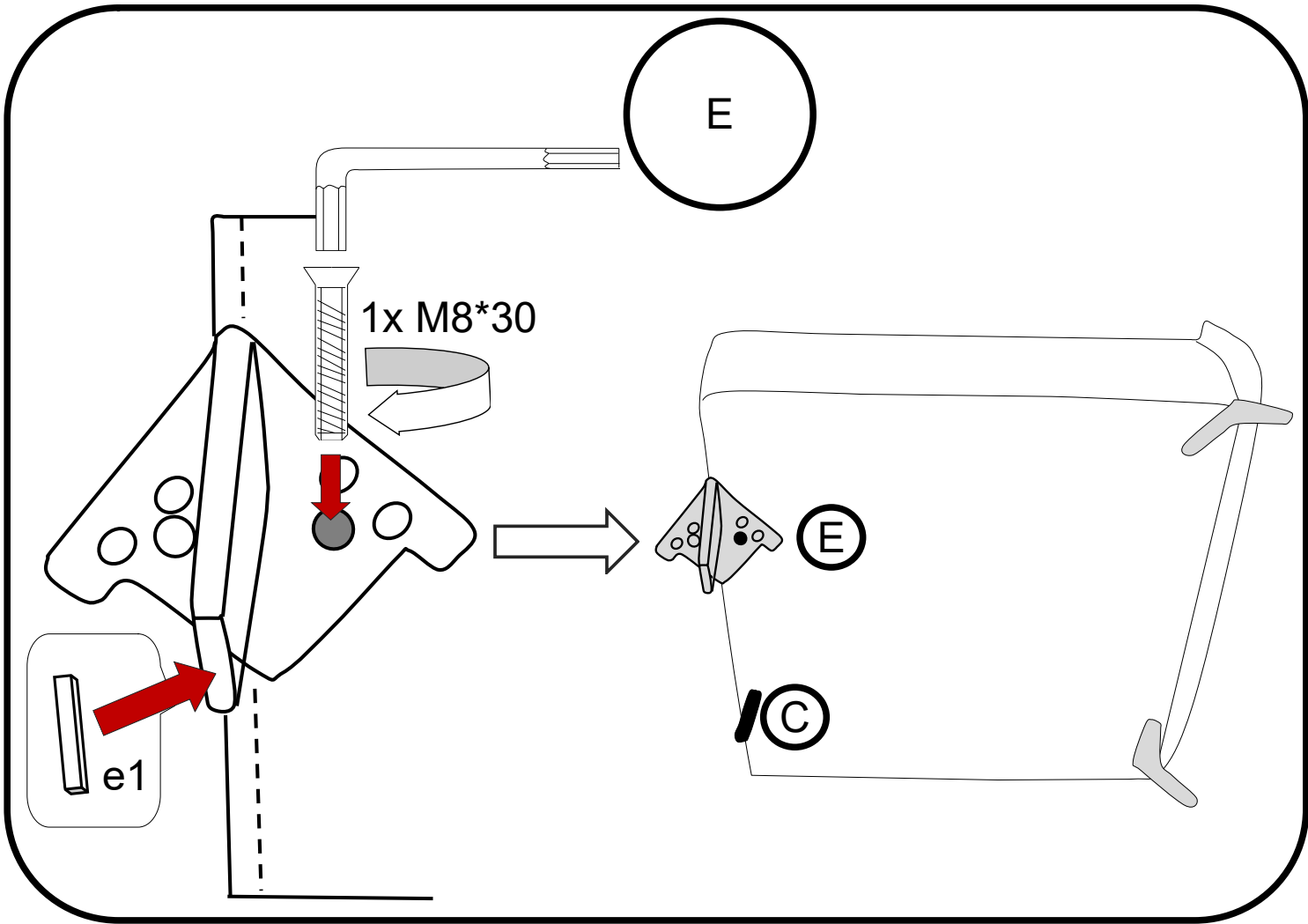

3

