

Multiflex Plus 2212/2214/2216

D

MONTAGEANLEITUNG
BEDIENUNGSANLEITUNG

NL

HANDLEIDING VOOR DE
MONTAGE
GEBRUIKSAANWIJZING

TR

MONTAJ TALIMATI
KULLANIM
KLAVUZU

RO

INSTRUCȚIUNI DE INSTALARE
INSTRUCȚIUNI DE UTILIZARE

FR

NOTICE DE MONTAGE
MANUEL INSTRUCTIONS

HU

KÖZGYŰLÉS UTASÍTÁSOK
KEZELÉSI UTASÍTÁS

SI

NAVODILA ZA MONTAŽO
NAVODILA ZA UPORABO

ES

INSTRUCCIONES DE MONTAJE
MANUAL DEL USUARIO

GB

ASSEMBLY
INSTRUCTIONS
INSTRUCTION MANUAL

PL

INSTRUKCJA
MONTAŻU
INSTRUKCJA OBSŁUGI

RU

ИНСТРУКЦИЯ ПО МОНТАЖУ
ИНСТРУКЦИЯ ПО
ЭКСПЛУАТАЦИИ

IT

ISTRUZIONI DI
MONTAGGIO
MANUALE DI ISTRUZIONI

SK

MONTÁŽNY NÁVOD
NÁVOD NA
POUŽITIE

CZ

MONTÁŽNÍ
NÁVOD
NÁVOD K POUŽITÍ

PT

INSTRUÇÕES DE
MONTAGEM
MANUAL DO USUÁRIO

HR

UPUTE ZA MONTAŽU
UPUTE ZA UPOTREBU

Service · Dienstverlening · Serwis · Servis · Сервисная служба · Serviciu · Services
· Servizio · Servisný list · Szolgáltatás · Servisní list

Name · Naam · Nazwa · Ísim · Название · Nume · Nome · Názov ·
Názov · Název · Neve

Multiflex Plus 2212/2214/2216

Тип · Type · Tip · Тип · Tipo · Típus

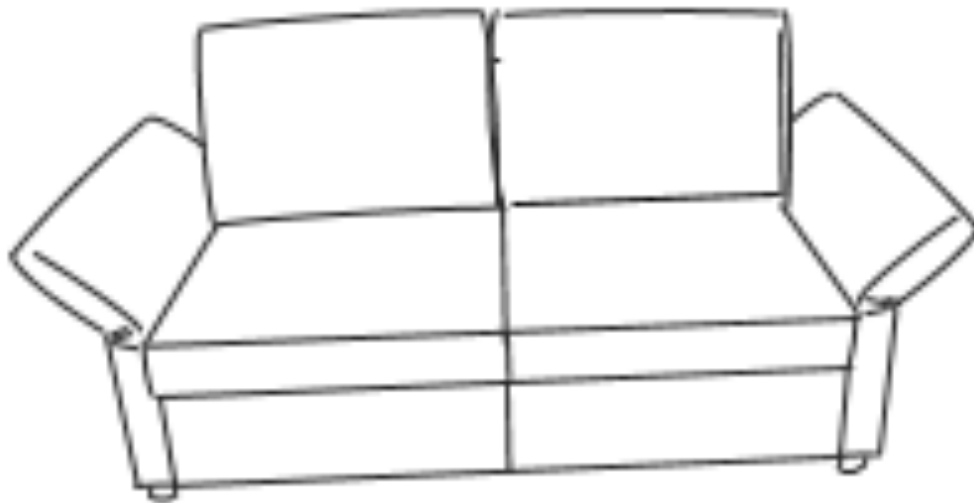
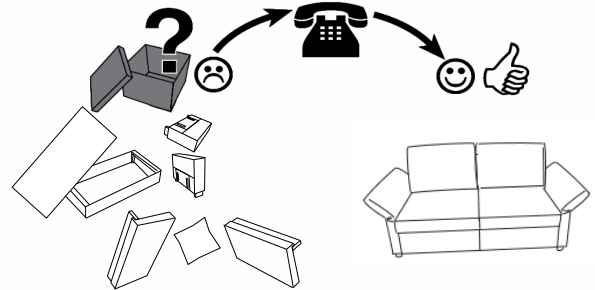
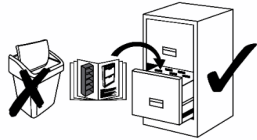

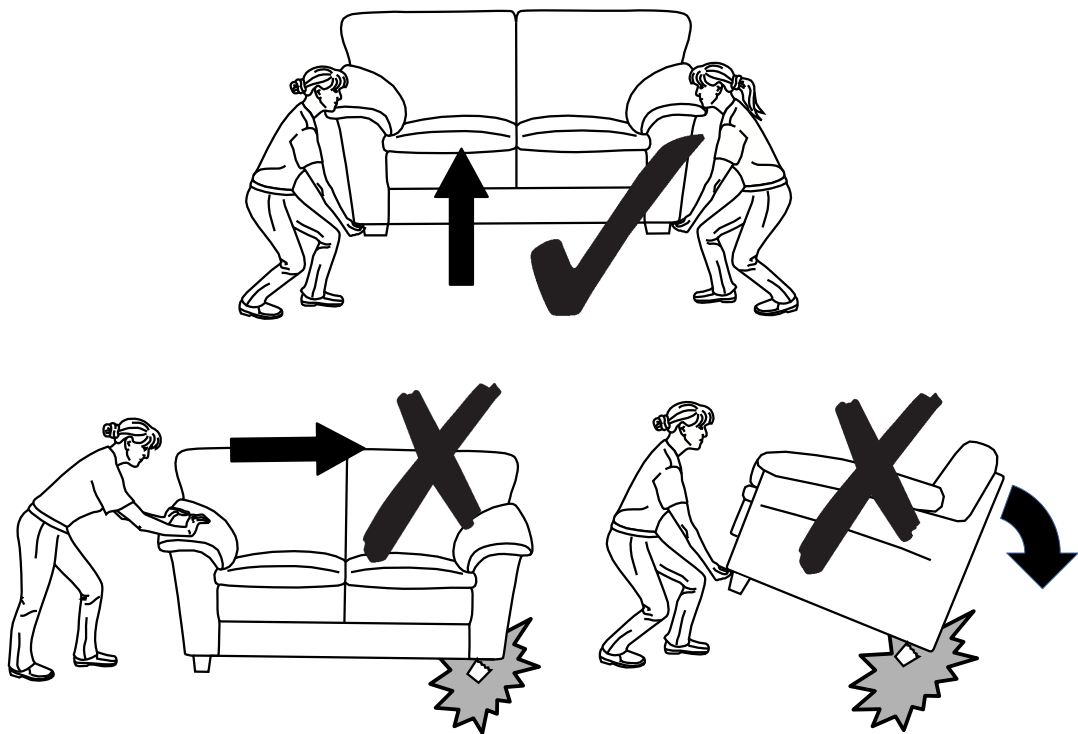
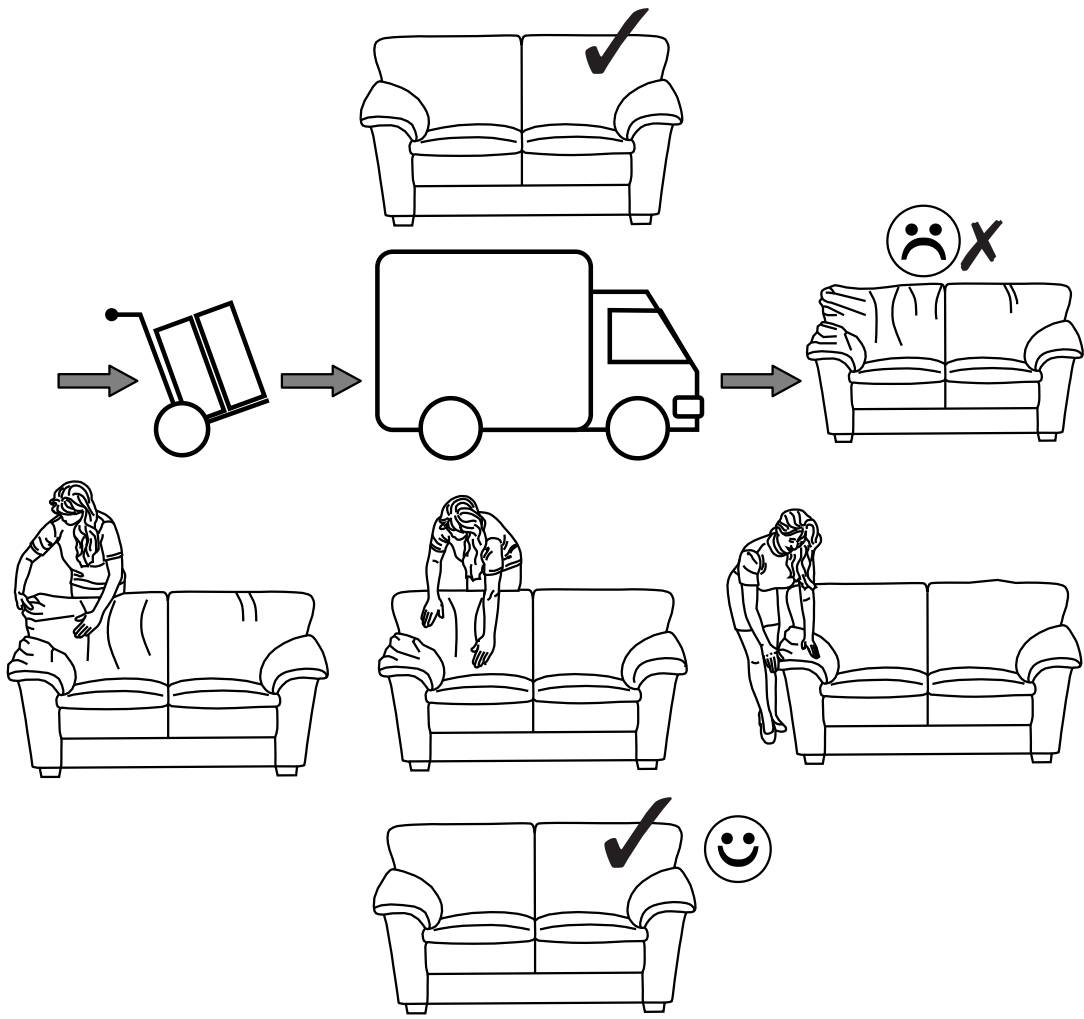

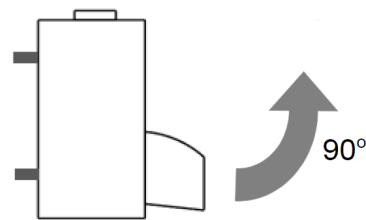
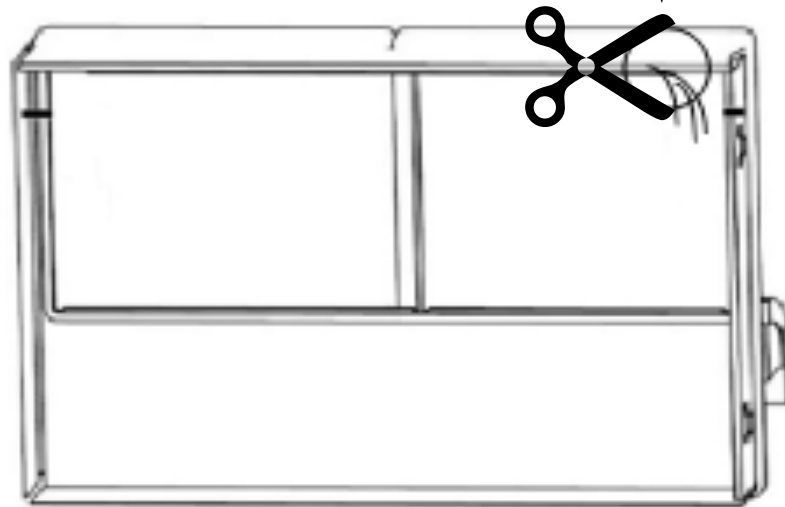
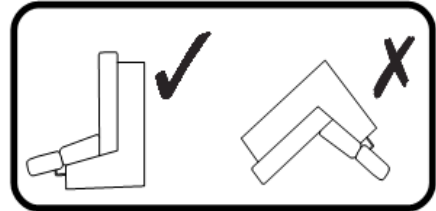
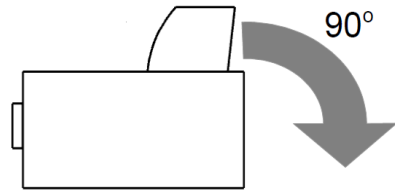
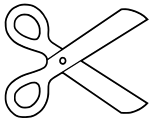

Relaxfunktion

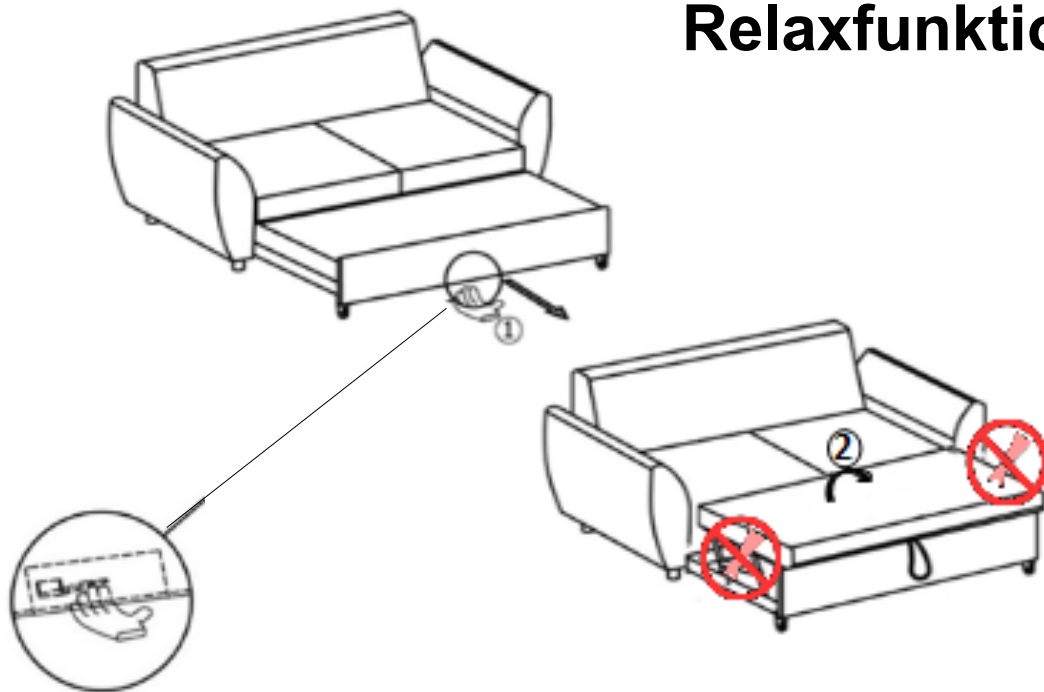

Bettfunktion

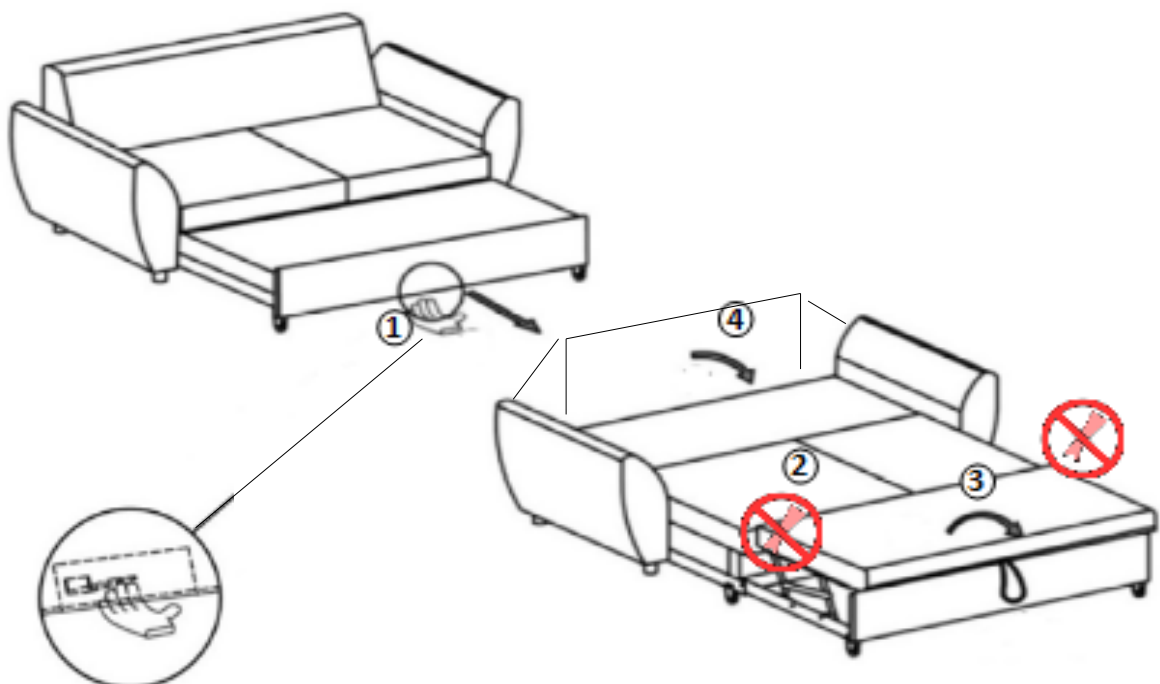

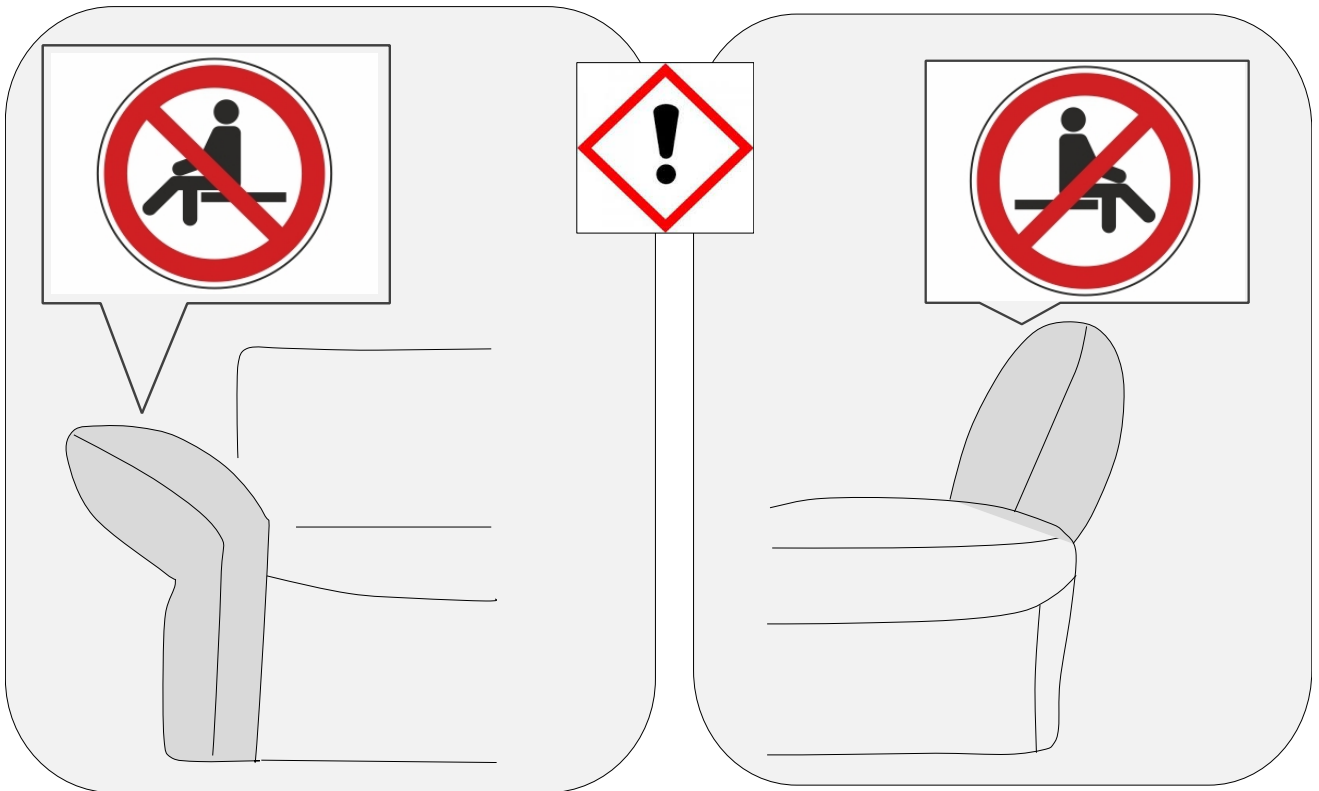
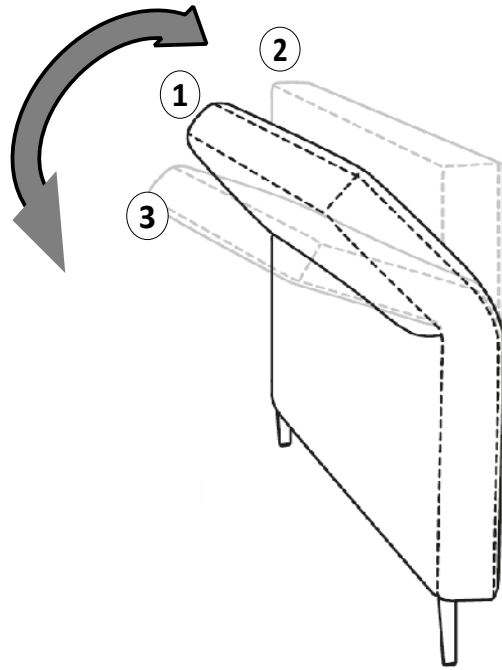

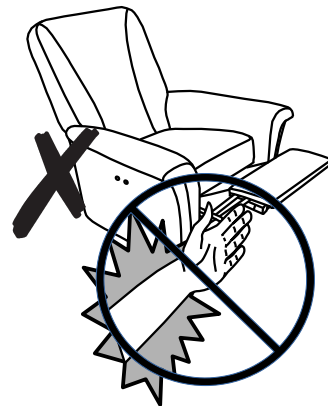
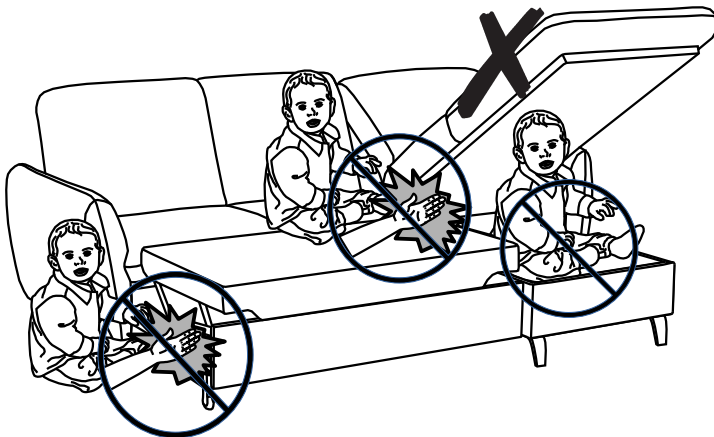
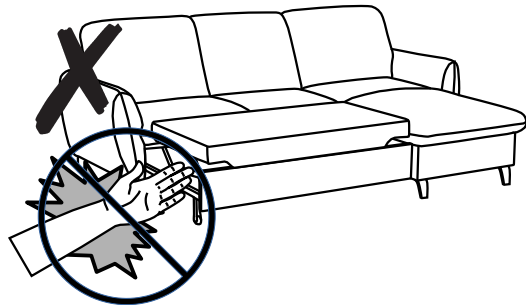
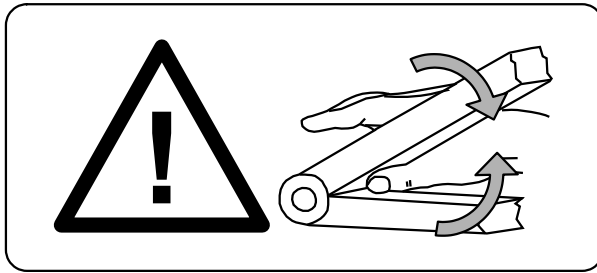
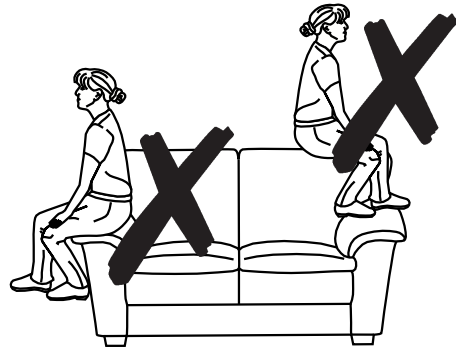
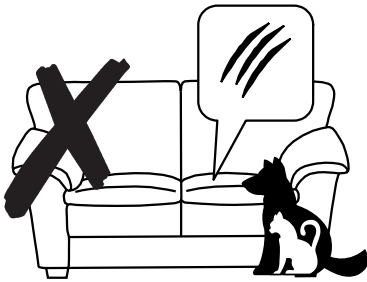
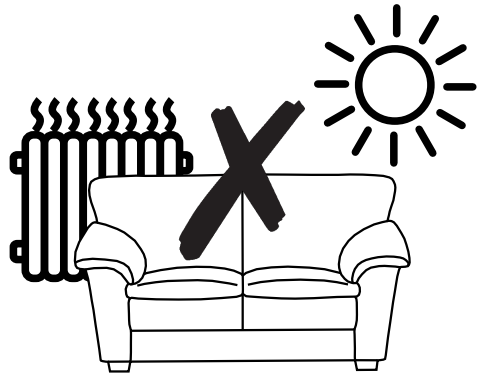

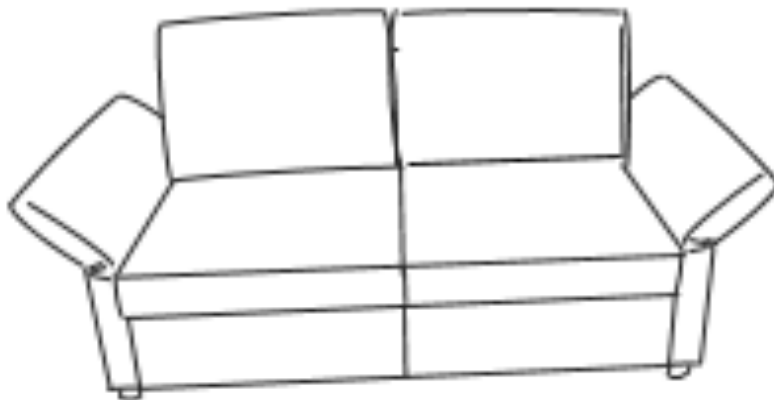
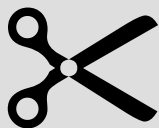
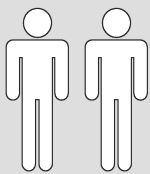

Multiflex Plus 2218 (2x90)

D

MONTAGEANLEITUNG
BEDIENUNGSANLEITUNG

NL

HANDLEIDING VOOR DE
MONTAGE
GEBRUIKSAANWIJZING

TR

MONTAJ TALIMATI
KULLANIM
KLAVUZU

RO

INSTRUCȚIUNI DE INSTALARE
INSTRUCȚIUNI DE UTILIZARE

FR

NOTICE DE MONTAGE
MANUEL INSTRUCTIONS

HU

KÖZGYŰLÉS UTASÍTÁSOK
KEZELÉSI UTASÍTÁS

SI

NAVODILA ZA MONTAŽO
NAVODILA ZA UPORABO

ES

INSTRUCCIONES DE MONTAJE
MANUAL DEL USUARIO

GB

ASSEMBLY
INSTRUCTIONS
INSTRUCTION MANUAL

PL

INSTRUKCJA
MONTAŻU
INSTRUKCJA OBSŁUGI

RU

ИНСТРУКЦИЯ ПО МОНТАЖУ
ИНСТРУКЦИЯ ПО
ЭКСПЛУАТАЦИИ

IT

ISTRUZIONI DI
MONTAGGIO
MANUALE DI ISTRUZIONI

SK

MONTÁŽNY NÁVOD
NÁVOD NA
POUŽITIE

CZ

MONTÁŽNÍ
NÁVOD
NÁVOD K POUŽITÍ

PT

INSTRUÇÕES DE
MONTAGEM
MANUAL DO USUÁRIO

HR

UPUTE ZA MONTAŽU
UPUTE ZA UPOTREBU

Service · Dienstverlening · Serwis · Servis · Сервисная служба · Serviciu · Services
· Servizio · Servisný list · Szolgáltatás · Servisní list

Name · Naam · Nazwa · Ísim · Название · Nume · Nome · Názov ·
Názov · Název · Neve

Multiflex Plus Typ 2218 (2x90)

Тип · Type · Tip · Тип · Tipo · Típus

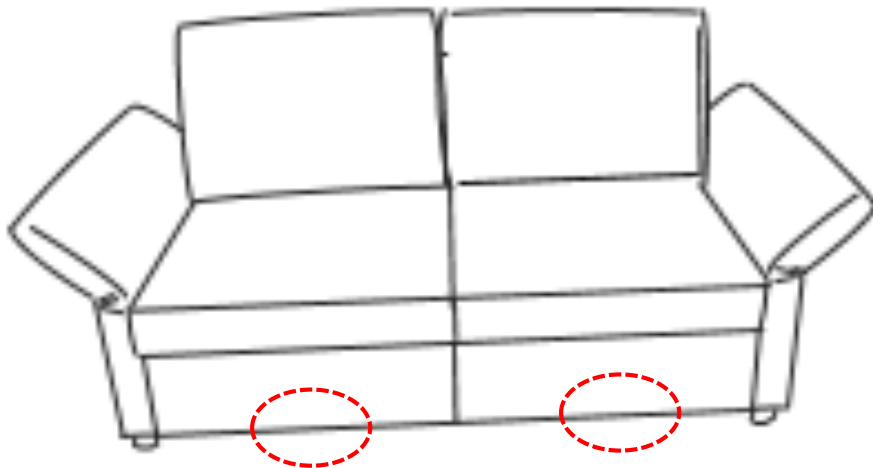
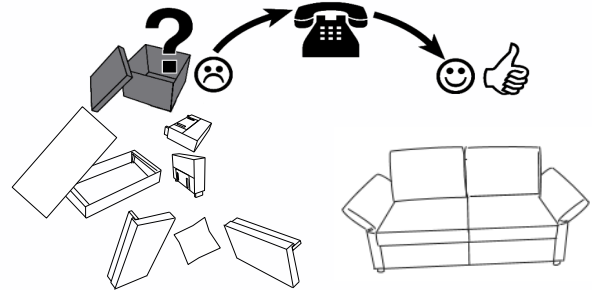
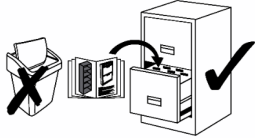

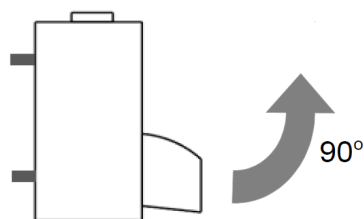
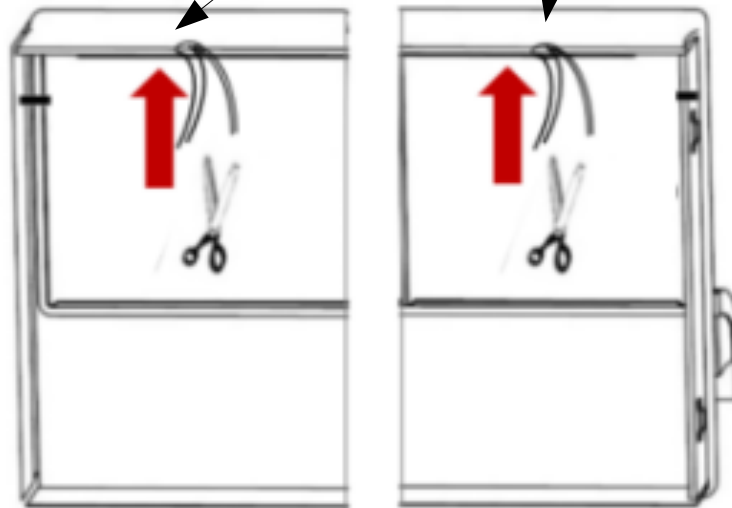
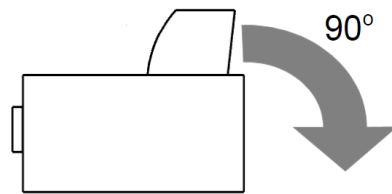
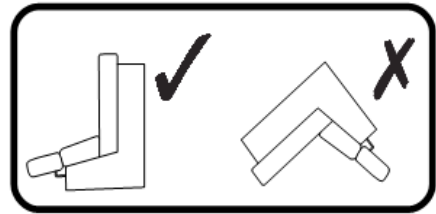
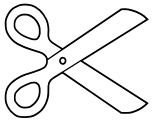

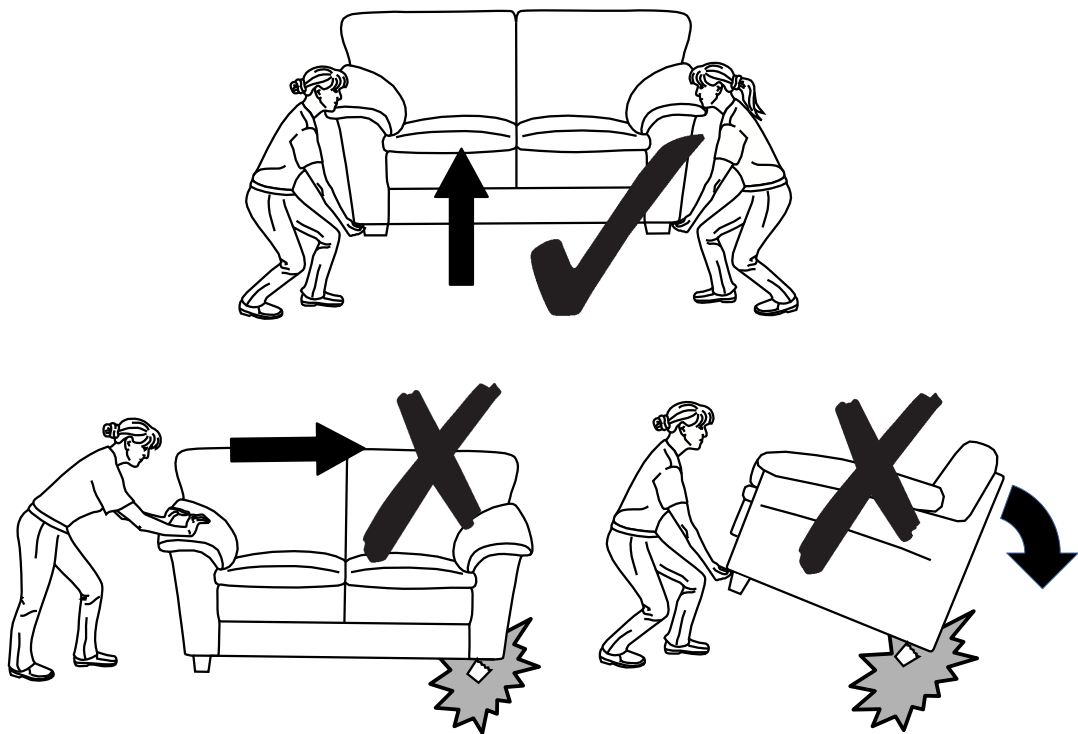
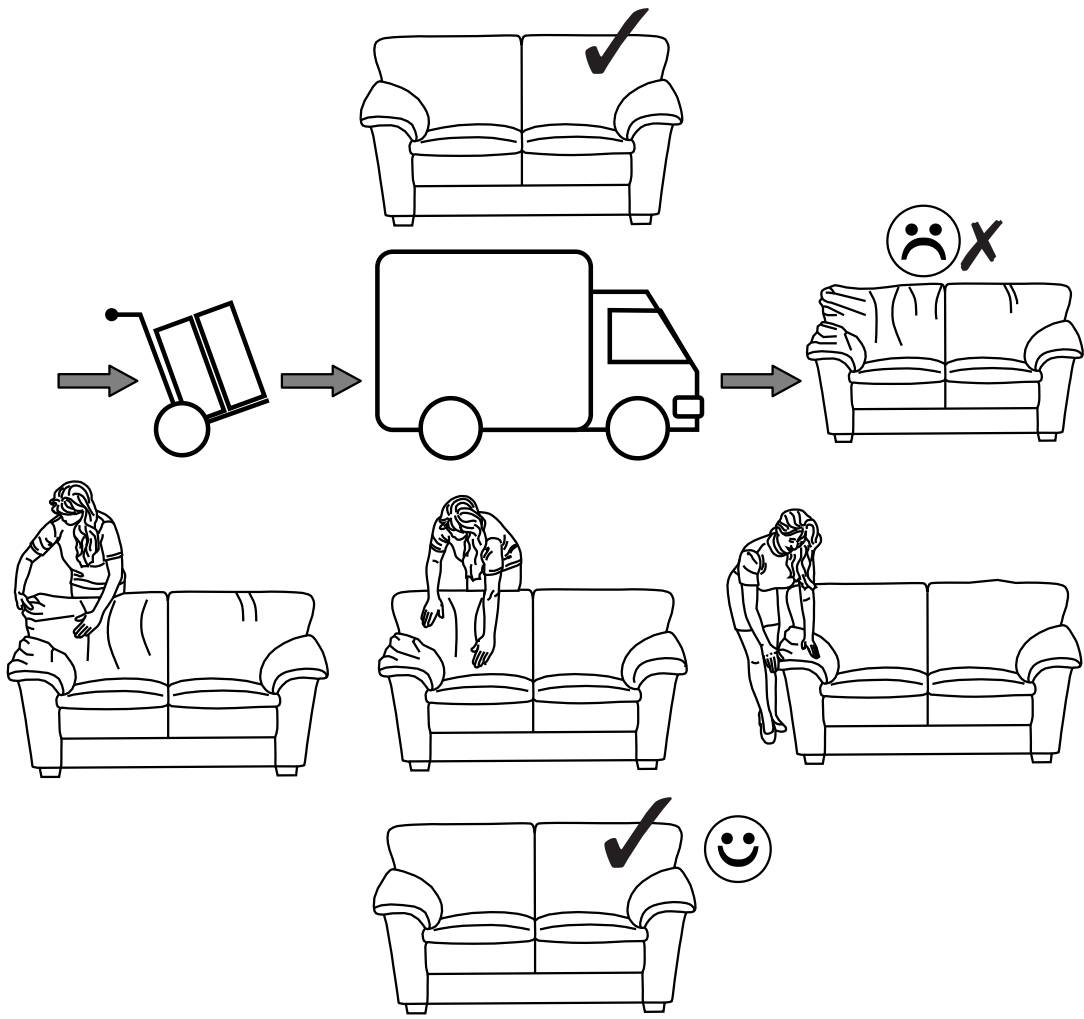

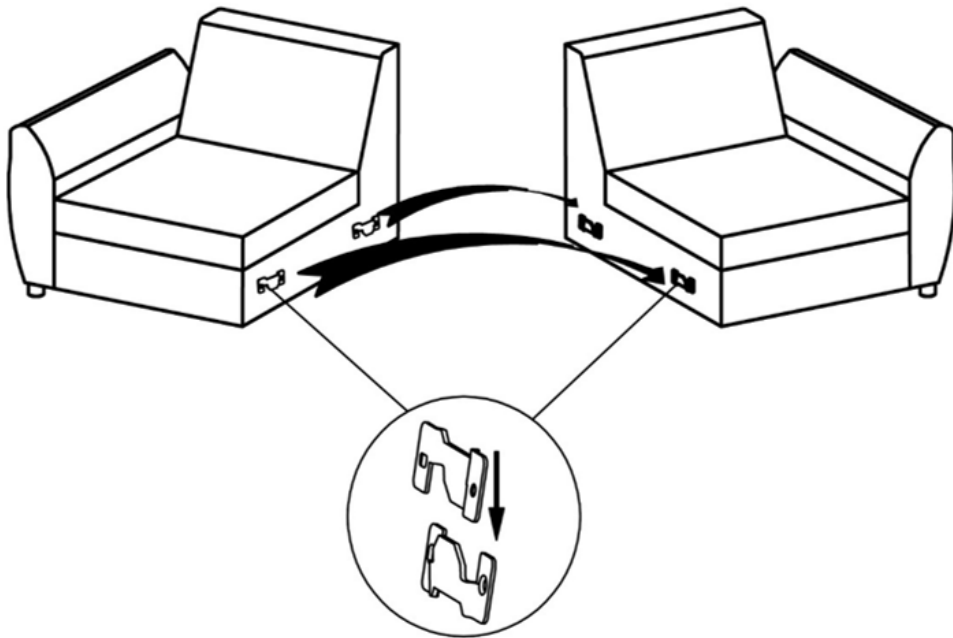
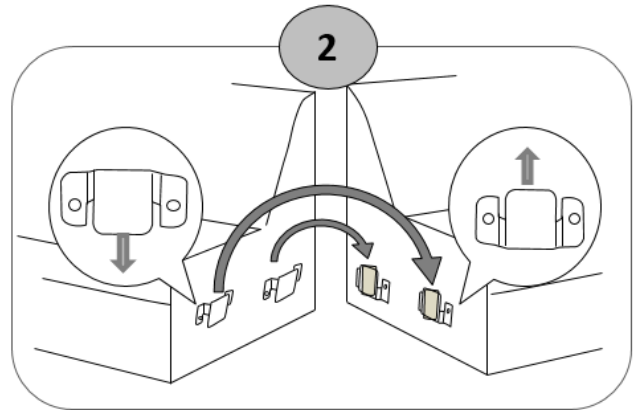
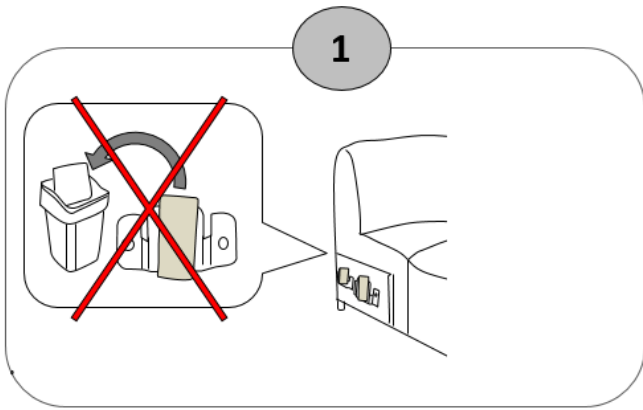

RELAXFUNKTION

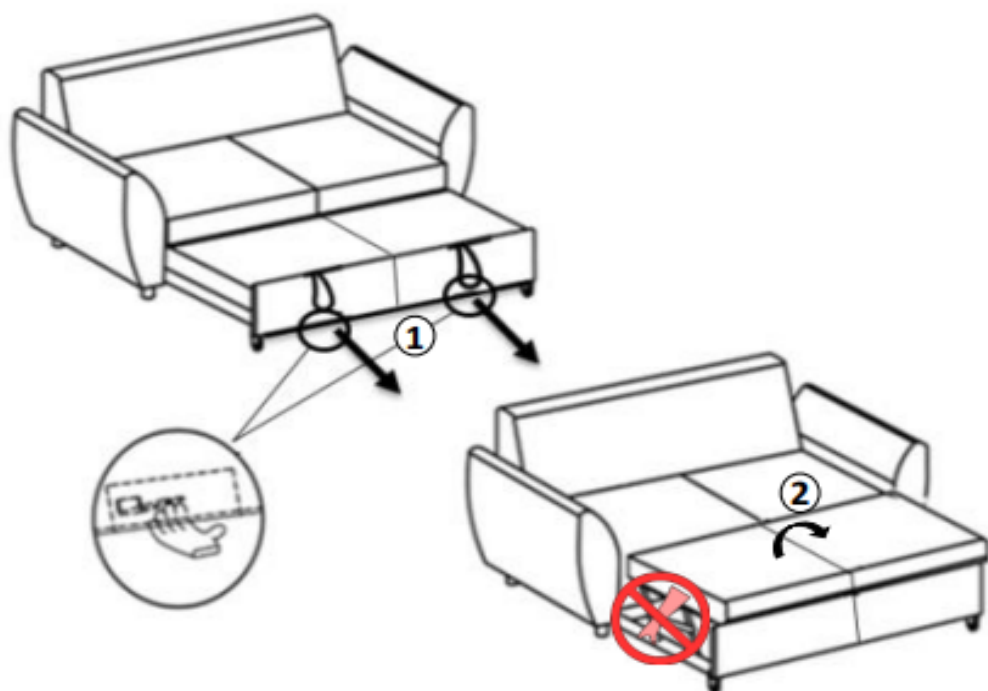

BETTFUNKTION

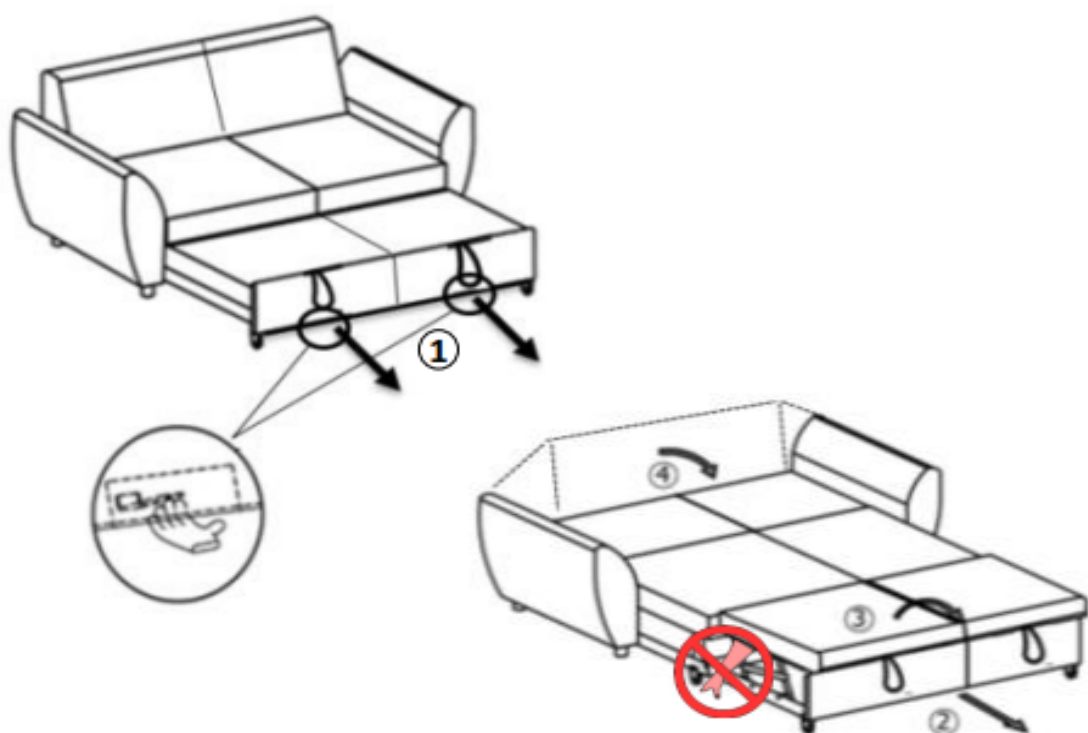

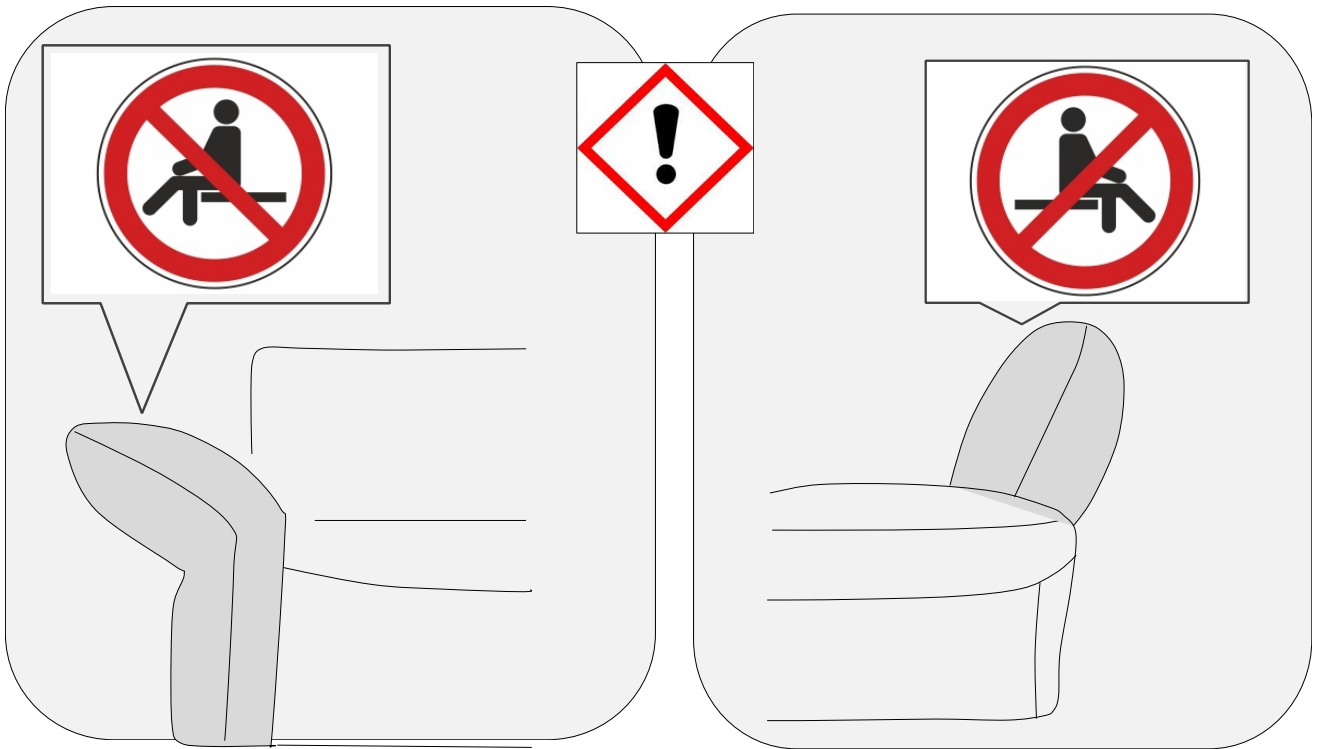
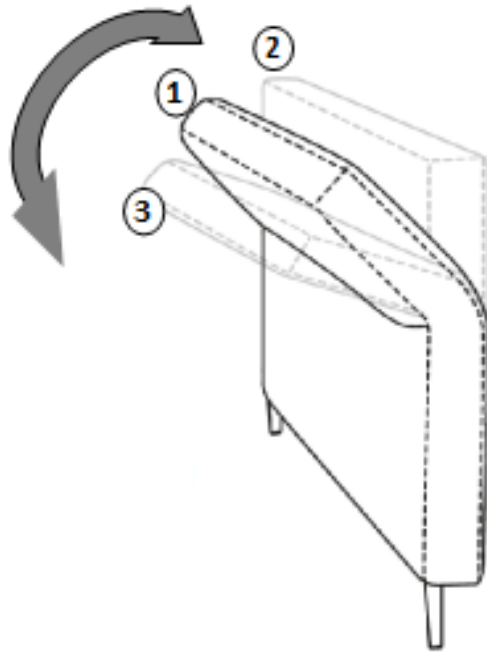

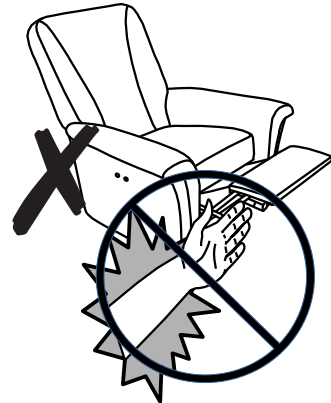
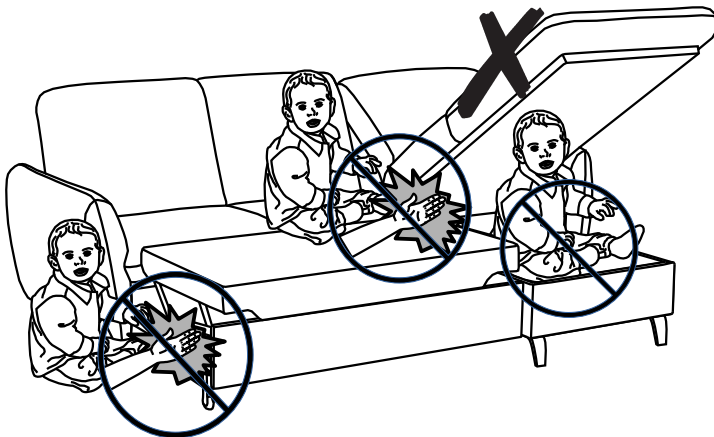
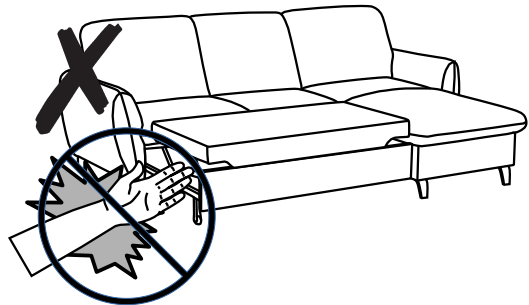
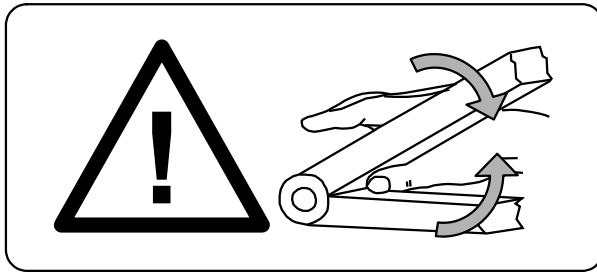
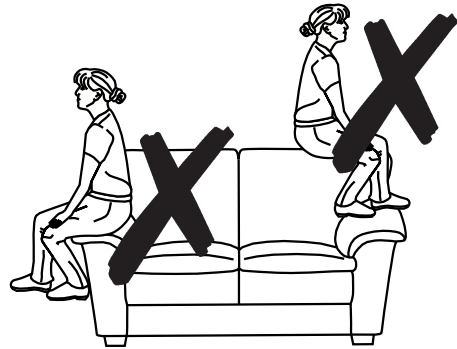
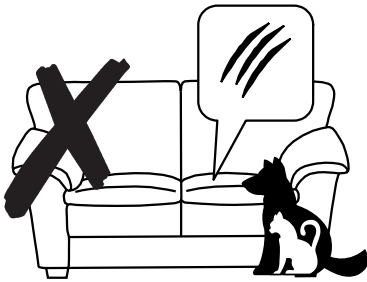
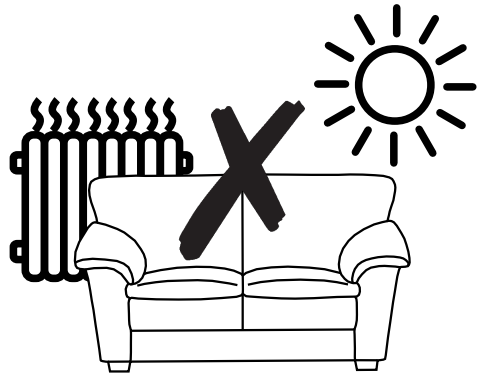

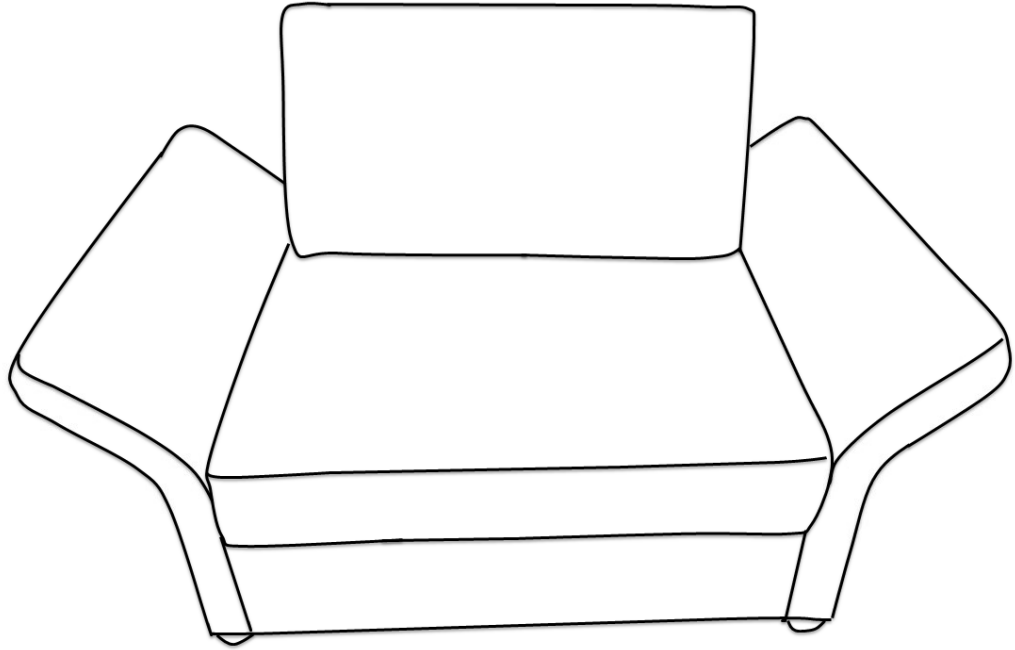
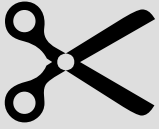
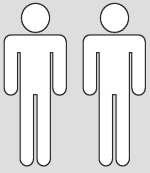

Multiflex Plus Sessel

- | | | | |
|-----------|--|-----------|--|
| D | MONTAGEANLEITUNG
BEDIENUNGSANLEITUNG | GB | ASSEMBLY
INSTRUCTIONS
INSTRUCTION MANUAL |
| NL | HANDLEIDING VOOR DE
MONTAGE
GEBRUIKSAANWIJZING | PL | INSTRUKCJA
MONTAŻU
INSTRUKCJA OBSŁUGI |
| TR | MONTAJ TALIMATI
KULLANIM
KLAVUZU | RU | ИНСТРУКЦИЯ ПО МОНТАЖУ
ИНСТРУКЦИЯ ПО
ЭКСПЛУАТАЦИИ |
| RO | INSTRUCȚIUNI DE INSTALARE
INSTRUCȚIUNI DE UTILIZARE | IT | ISTRUZIONI DI
MONTAGGIO
MANUALE DI ISTRUZIONI |
| FR | NOTICE DE MONTAGE
MANUEL INSTRUCTIONS | SK | MONTÁŽNY NÁVOD
NÁVOD NA
POUŽITIE |
| HU | KÖZGYŰLÉS UTASÍTÁSOK
KEZELÉSI UTASÍTÁS | CZ | MONTÁŽNÍ
NÁVOD
NÁVOD K POUŽITÍ |
| SI | NAVODILA ZA MONTAŽO
NAVODILA ZA UPORABO | PT | INSTRUÇÕES DE
MONTAGEM
MANUAL DO USUÁRIO |
| ES | INSTRUCCIONES DE MONTAJE
MANUAL DEL USUARIO | HR | UPUTE ZA MONTAŽU
UPUTE ZA UPOTREBU |

Service · Dienstverlening · Serwis · Servis · Сервисная служба · Serviciu · Services
· Servizio · Servisný list · Szolgáltatás · Servisní list

Name · Naam · Nazwa · İsim · Название · Nume · Nome · Názov ·
Názov · Název · Neve

Multiflex Plus Sessel

Typ · Type · Tip · Тип · Tipo · Típus

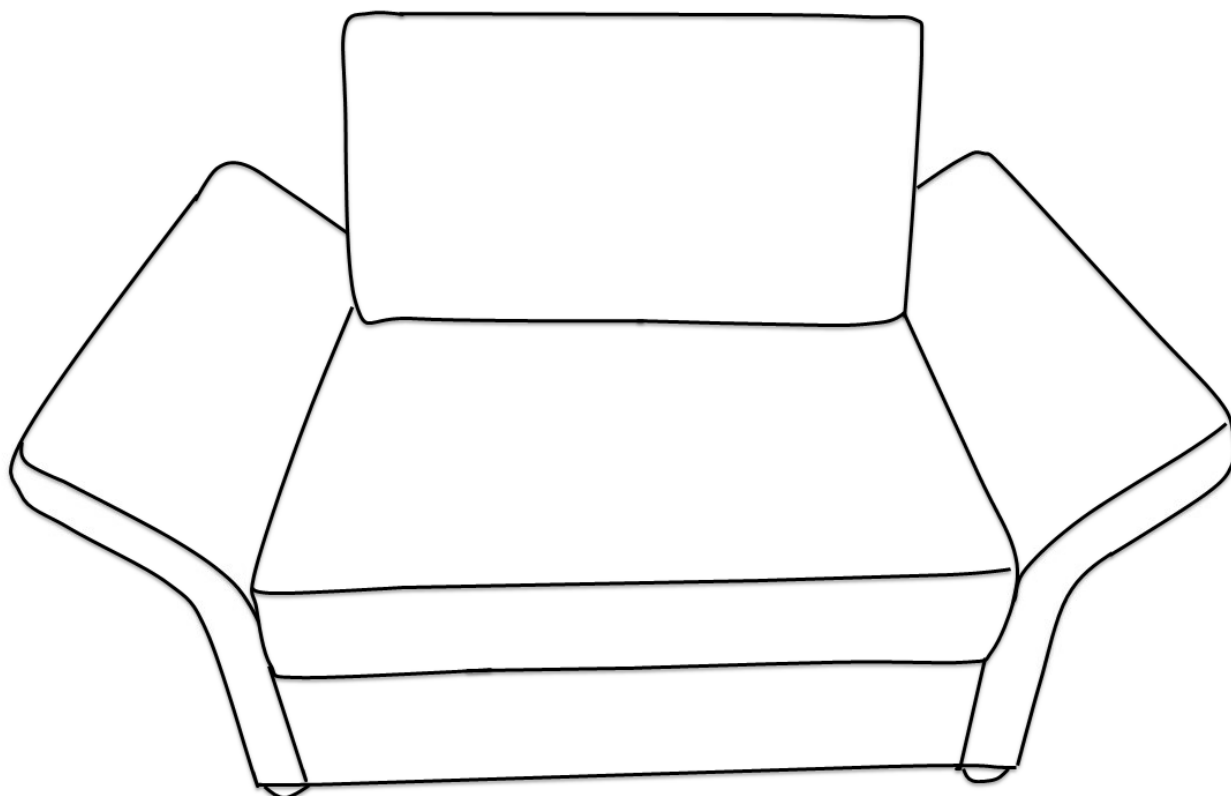
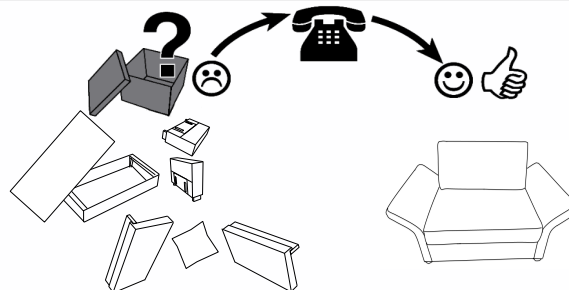
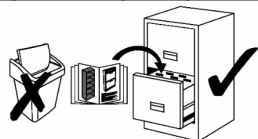

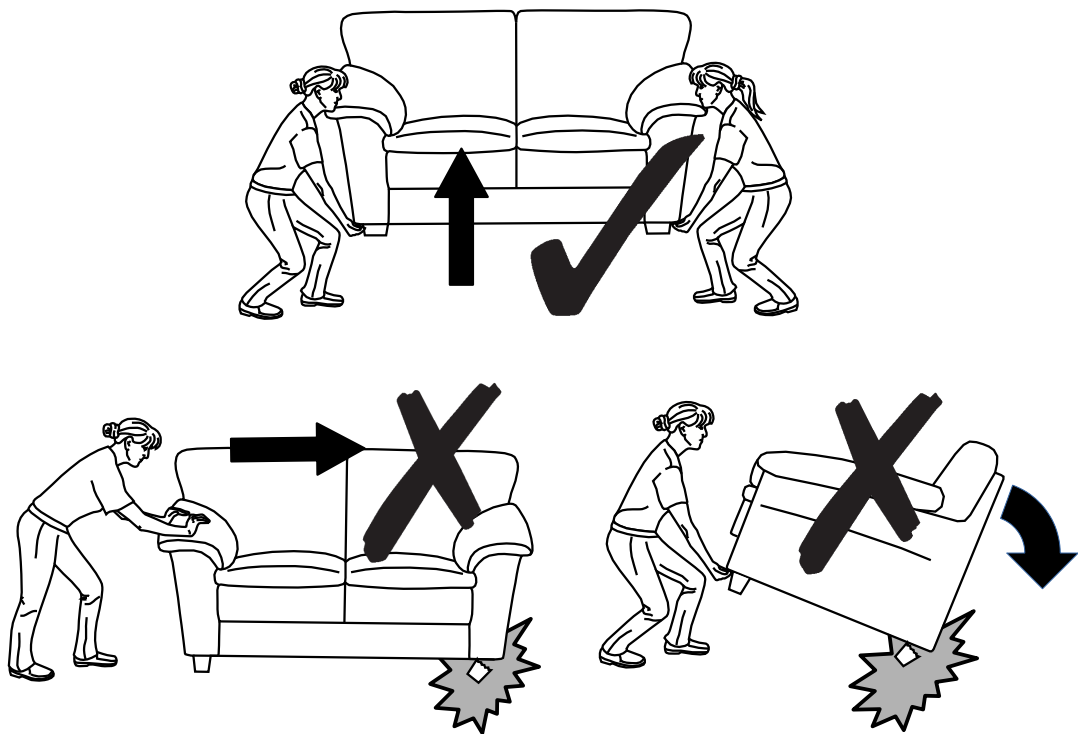
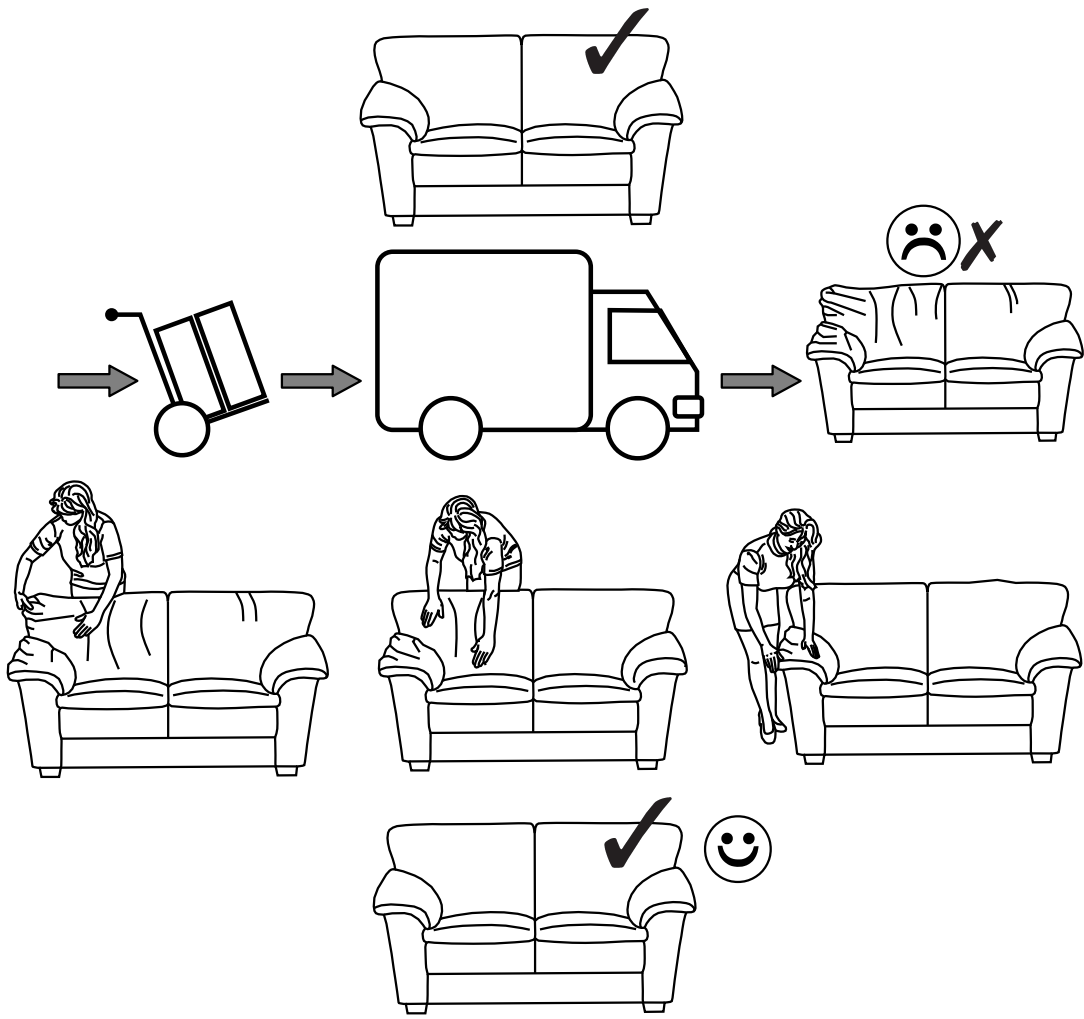

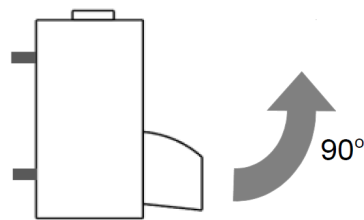
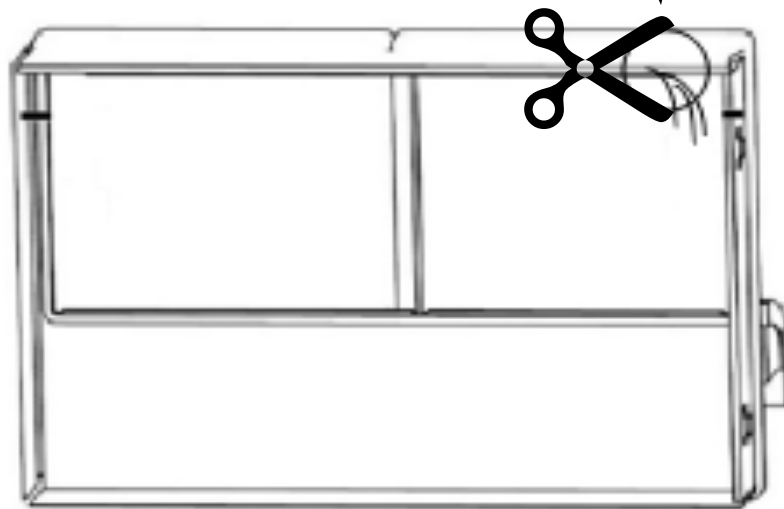
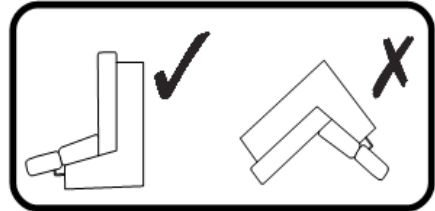
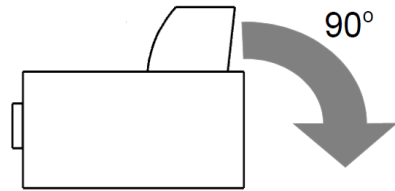
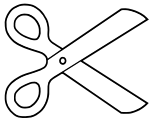

Bettfunktion

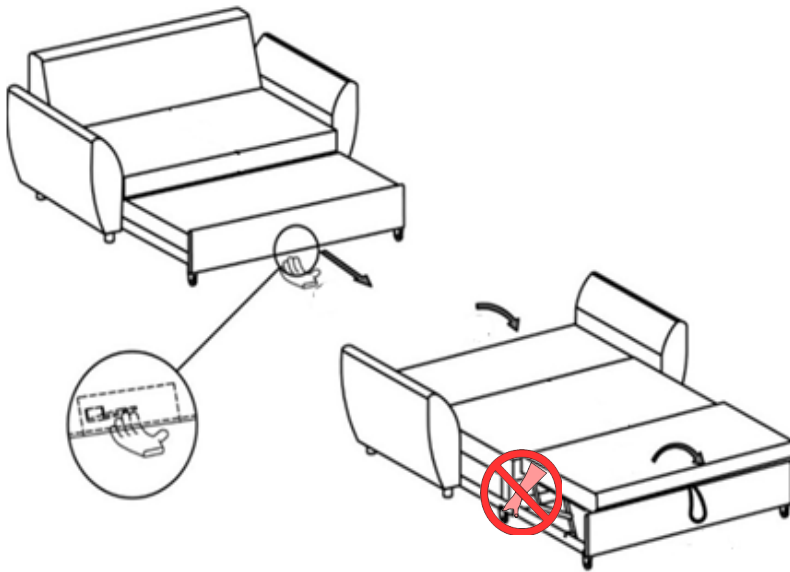

Relaxfunktion

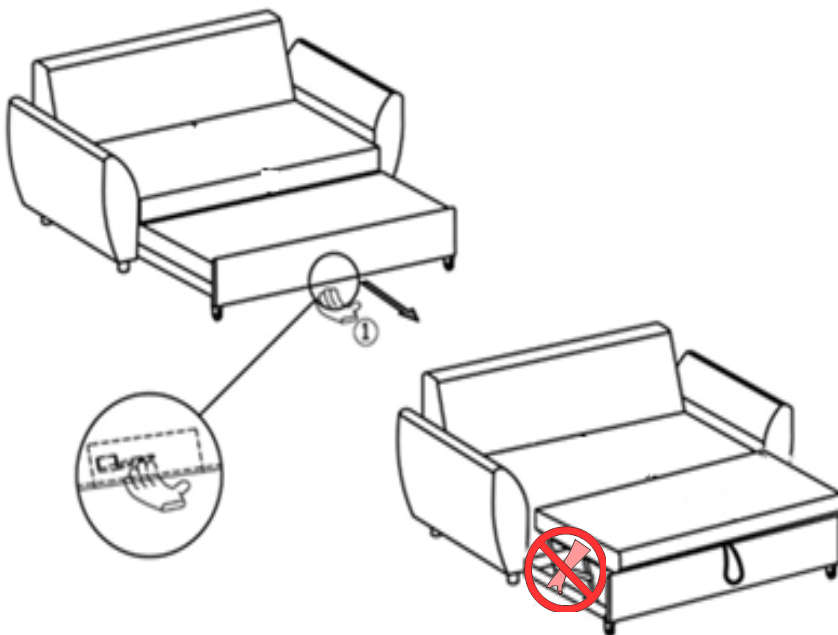

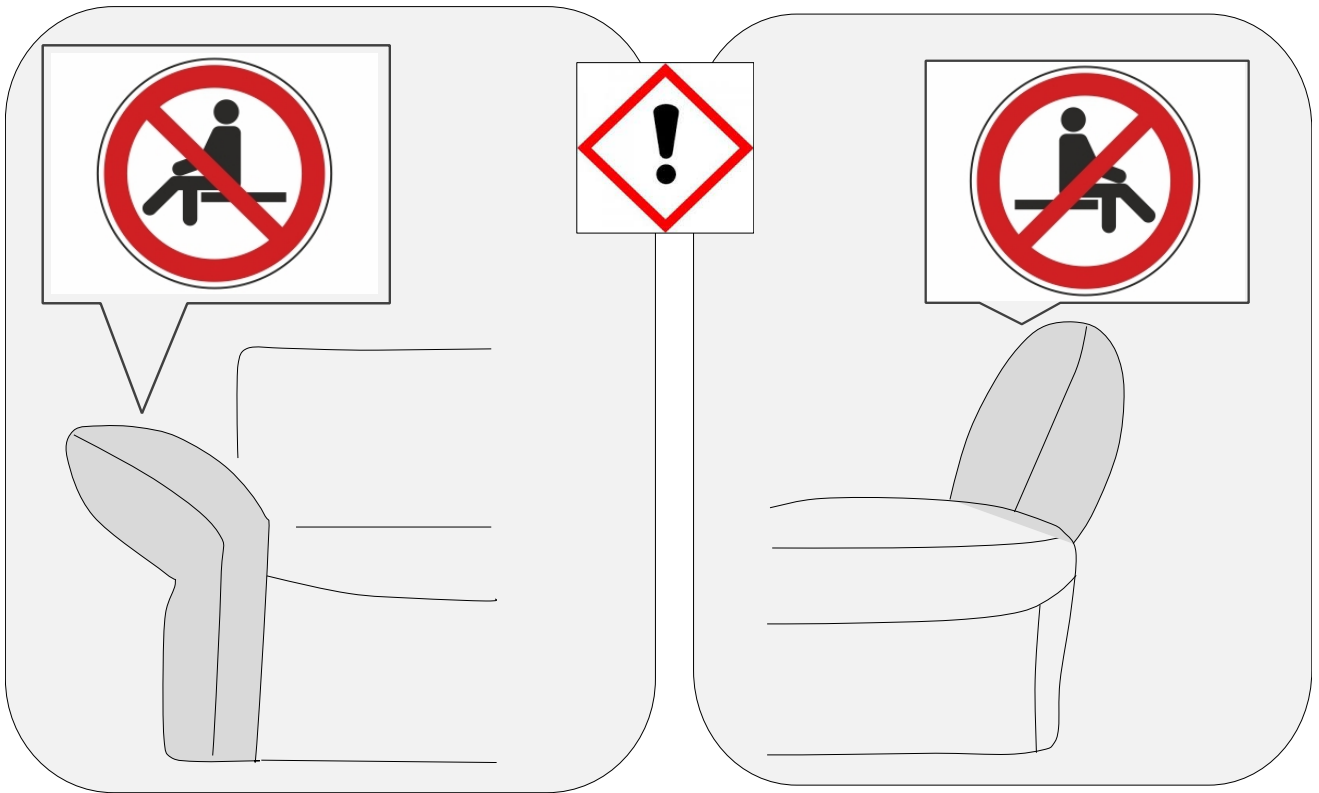
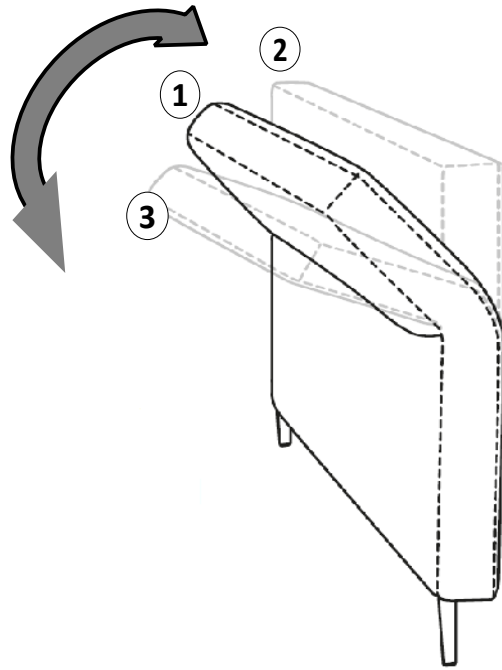

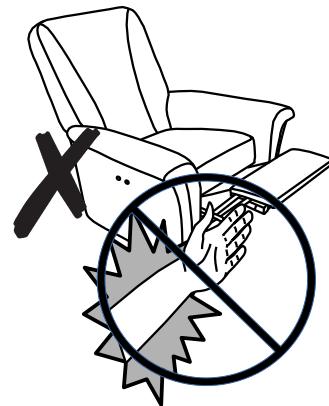
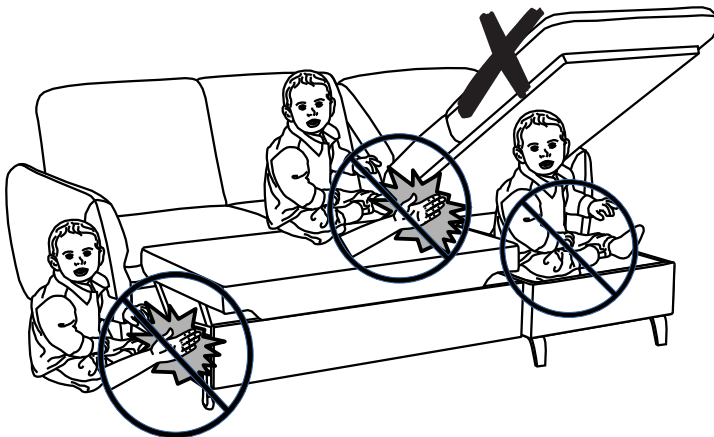
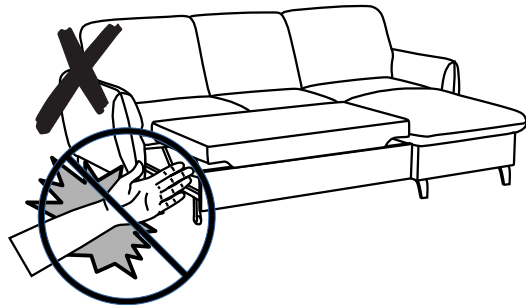
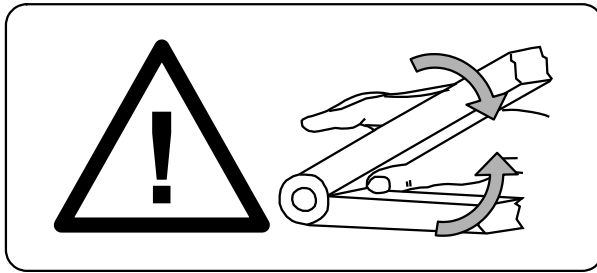
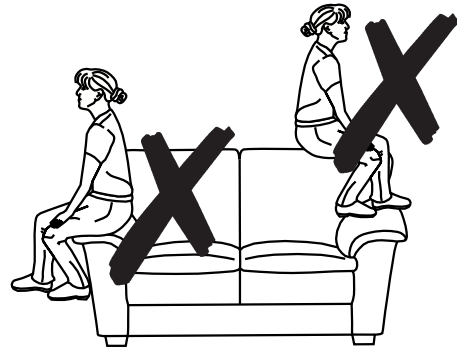
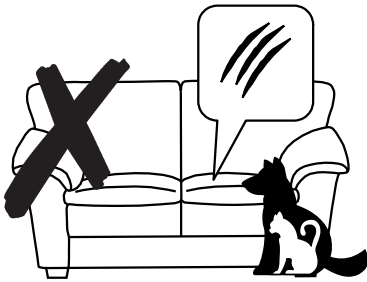
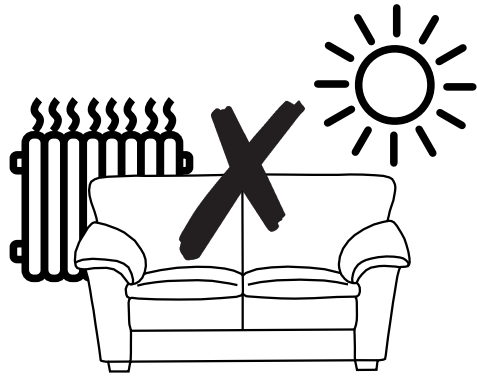

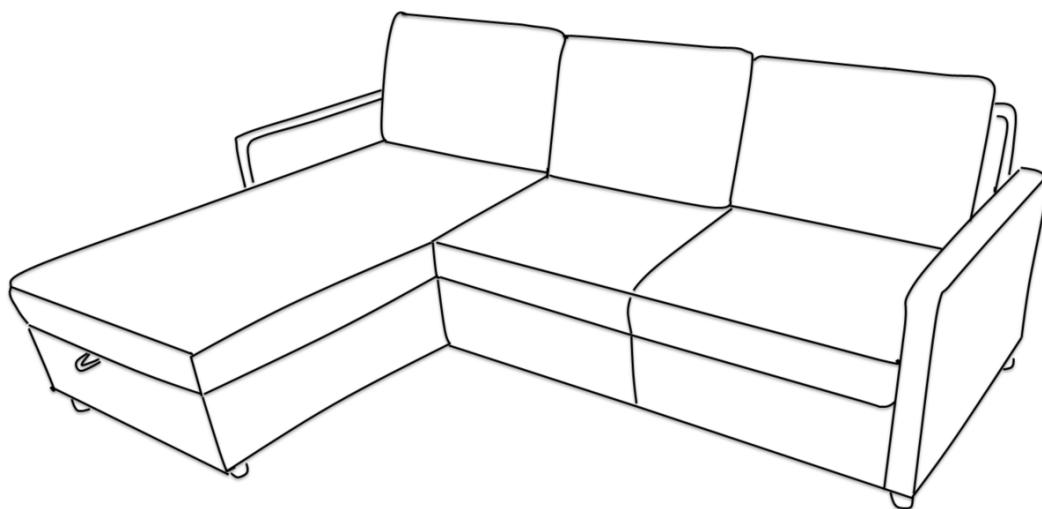
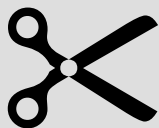
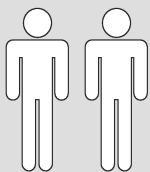

Multiflex Plus Sofa+Longchair

D

MONTAGEANLEITUNG
BEDIENUNGSANLEITUNG

NL

HANDLEIDING VOOR DE
MONTAGE
GEBRUIKSAANWIJZING

TR

MONTAJ TALIMATI
KULLANIM
KLAVUZU

RO

INSTRUCȚIUNI DE INSTALARE
INSTRUCȚIUNI DE UTILIZARE

FR

NOTICE DE MONTAGE
MANUEL INSTRUCTIONS

HU

KÖZGYŰLÉS UTASÍTÁSOK
KEZELÉSI UTASÍTÁS

SI

NAVODILA ZA MONTAŽO
NAVODILA ZA UPORABO

ES

INSTRUCCIONES DE MONTAJE
MANUAL DEL USUARIO

GB

ASSEMBLY
INSTRUCTIONS
INSTRUCTION MANUAL

PL

INSTRUKCJA
MONTAŻU
INSTRUKCJA OBSŁUGI

RU

ИНСТРУКЦИЯ ПО МОНТАЖУ
ИНСТРУКЦИЯ ПО
ЭКСПЛУАТАЦИИ

IT

ISTRUZIONI DI
MONTAGGIO
MANUALE DI ISTRUZIONI

SK

MONTÁŽNY NÁVOD
NÁVOD NA
POUŽITIE

CZ

MONTÁŽNÍ
NÁVOD
NÁVOD K POUŽITÍ

PT

INSTRUÇÕES DE
MONTAGEM
MANUAL DO USUÁRIO

HR

UPUTE ZA MONTAŽU
UPUTE ZA UPOTREBU

Service · Dienstverlening · Serwis · Servis · Сервисная служба · Serviciu · Services
· Servizio · Servisný list · Szolgáltatás · Servisní list

Name · Naam · Nazwa · İsim · Название · Nume · Nome · Názov ·
Názov · Název · Neve

Multiflex Plus Sofa + Longchair

Тип · Type · Tip · Тип · Típo · Típus

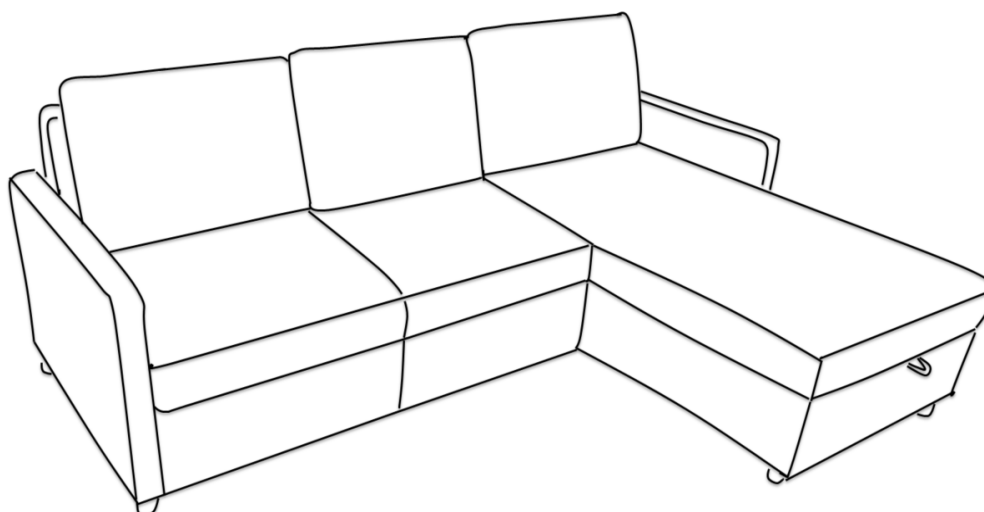
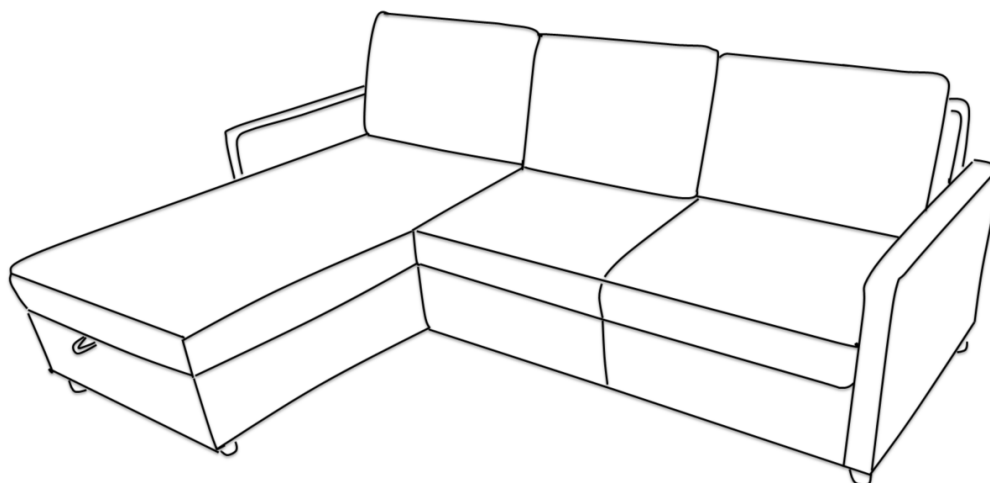
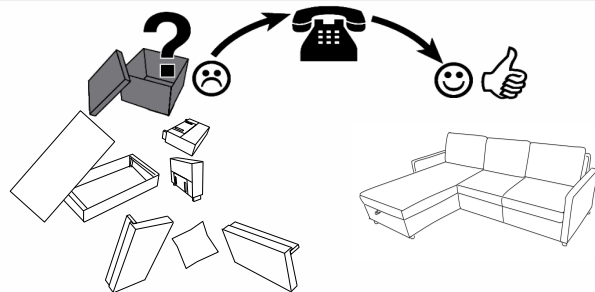
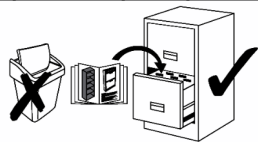

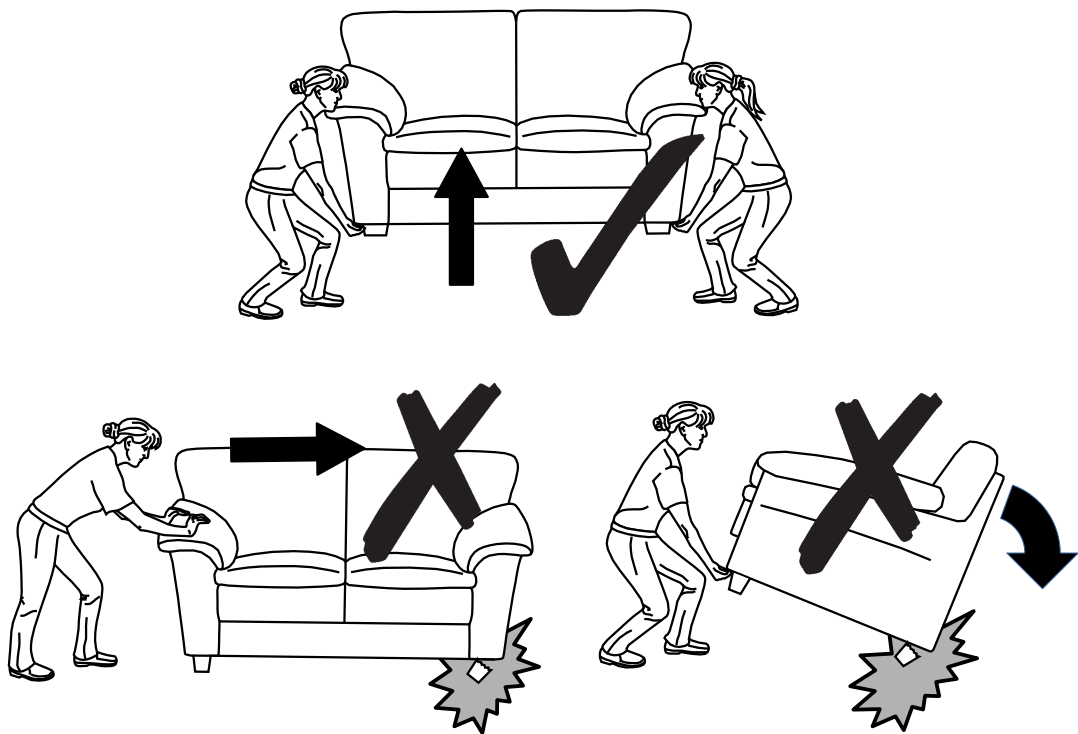
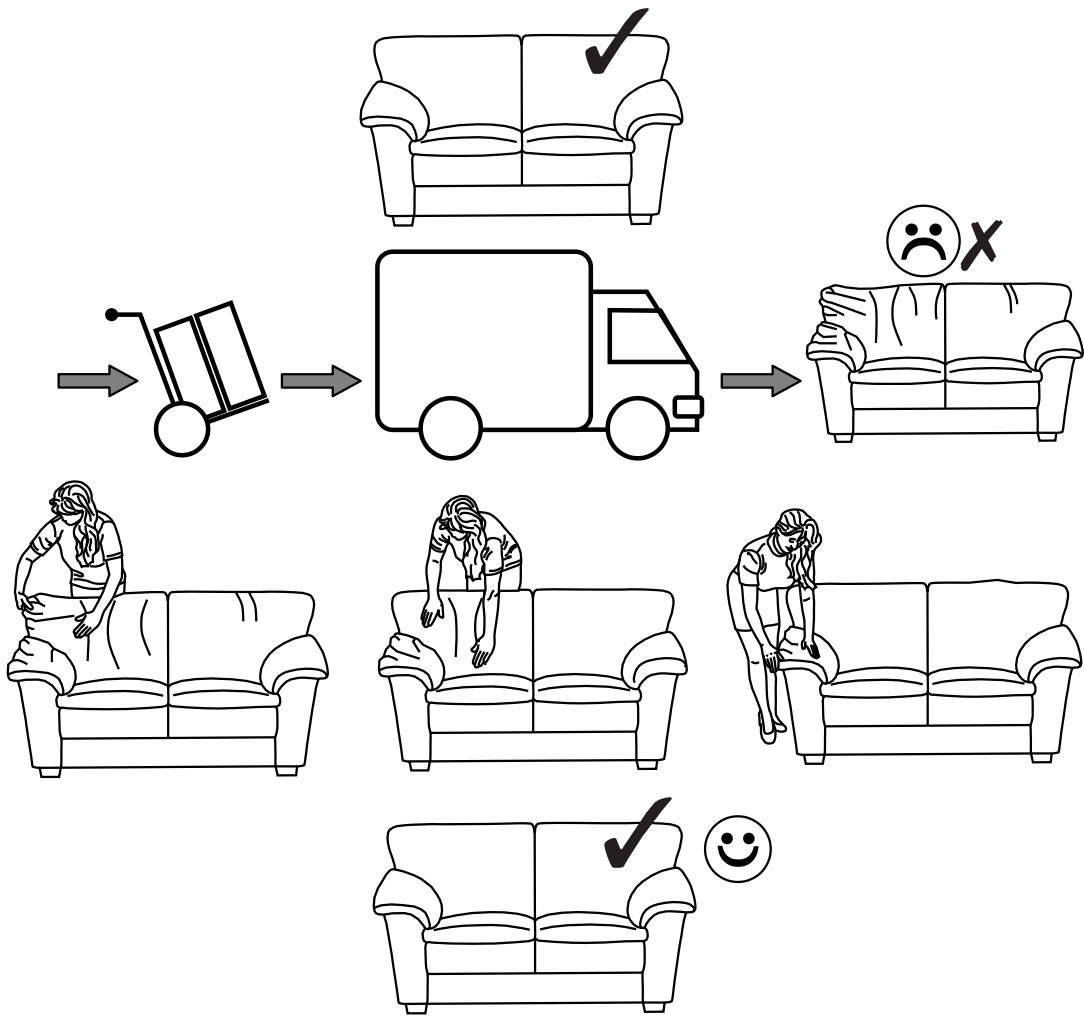

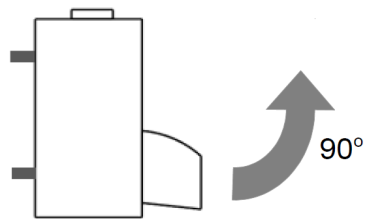
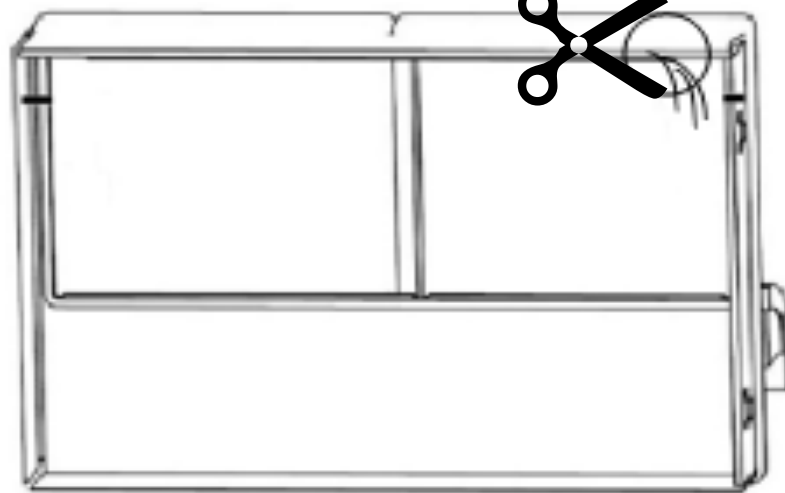
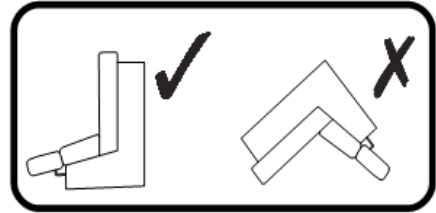
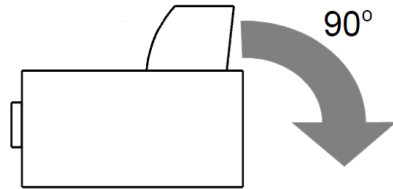
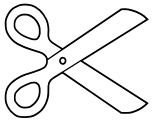

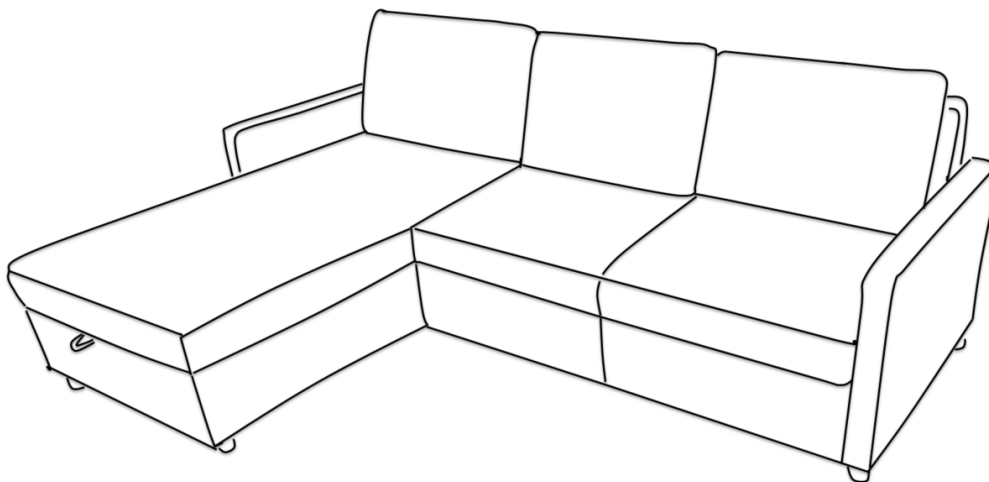
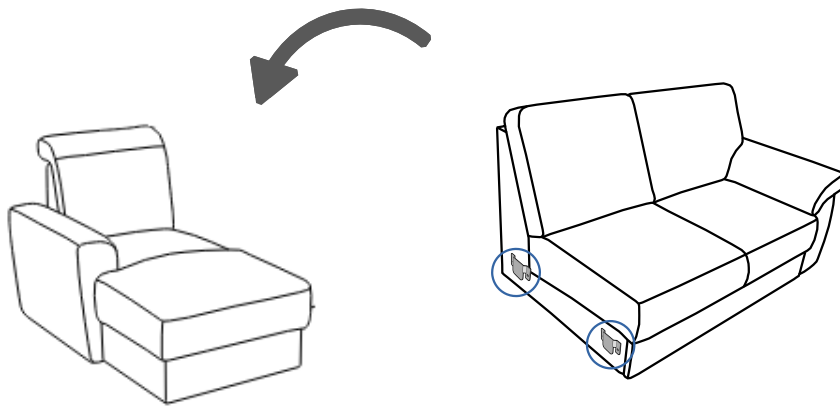
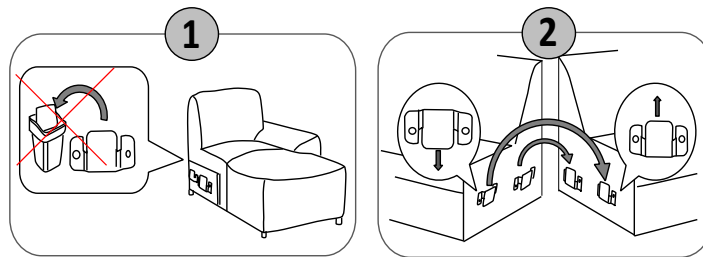

BETTFUNKTION

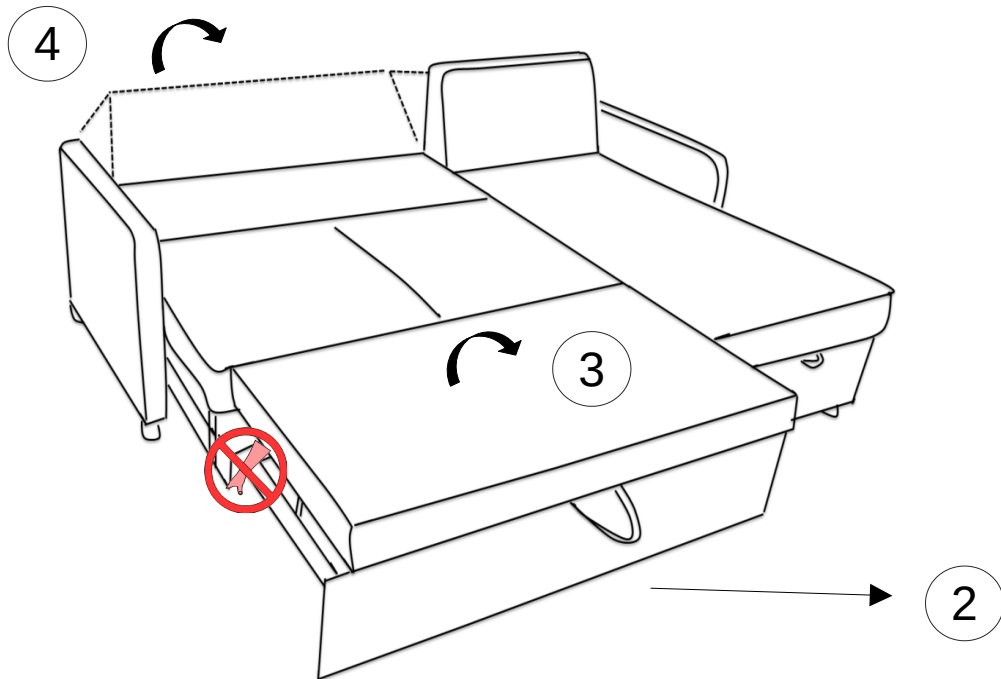
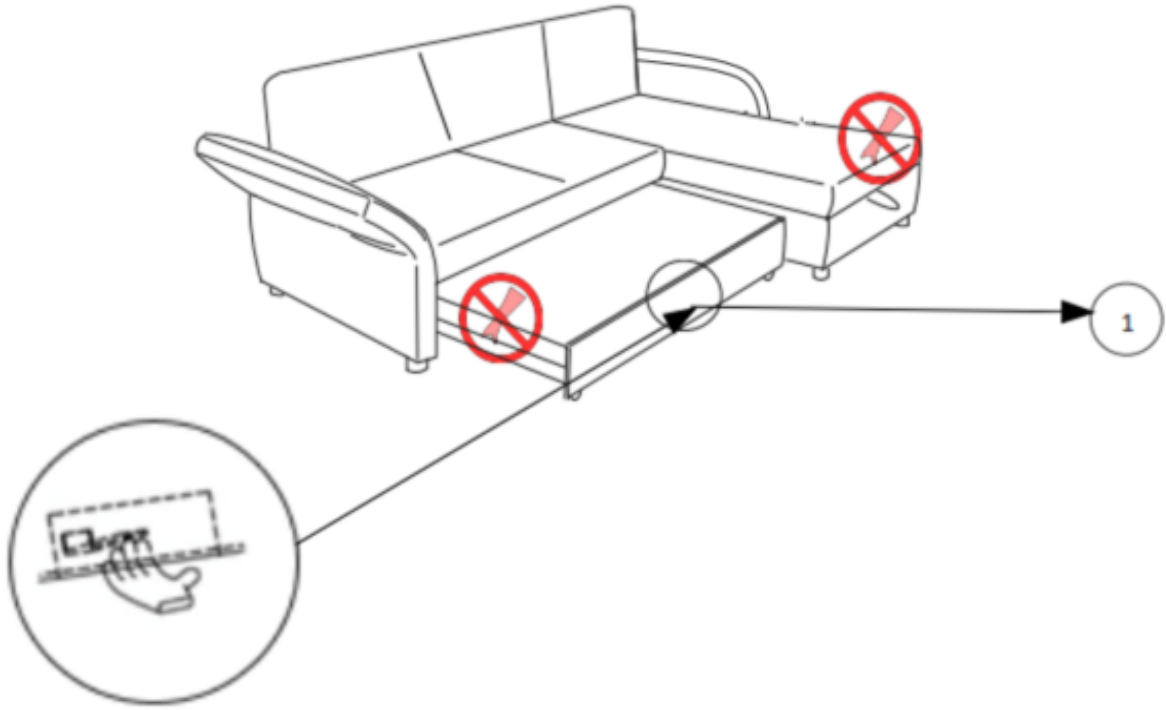

RELAXFUNKTION

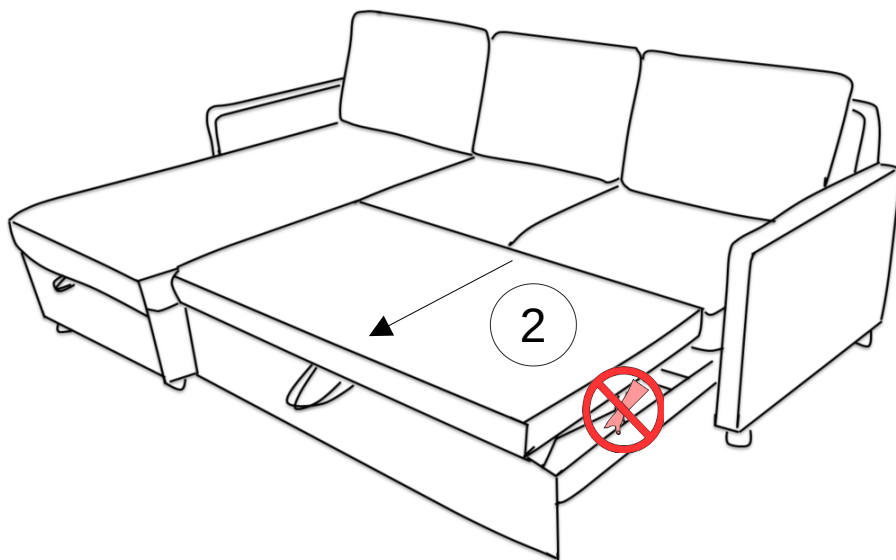
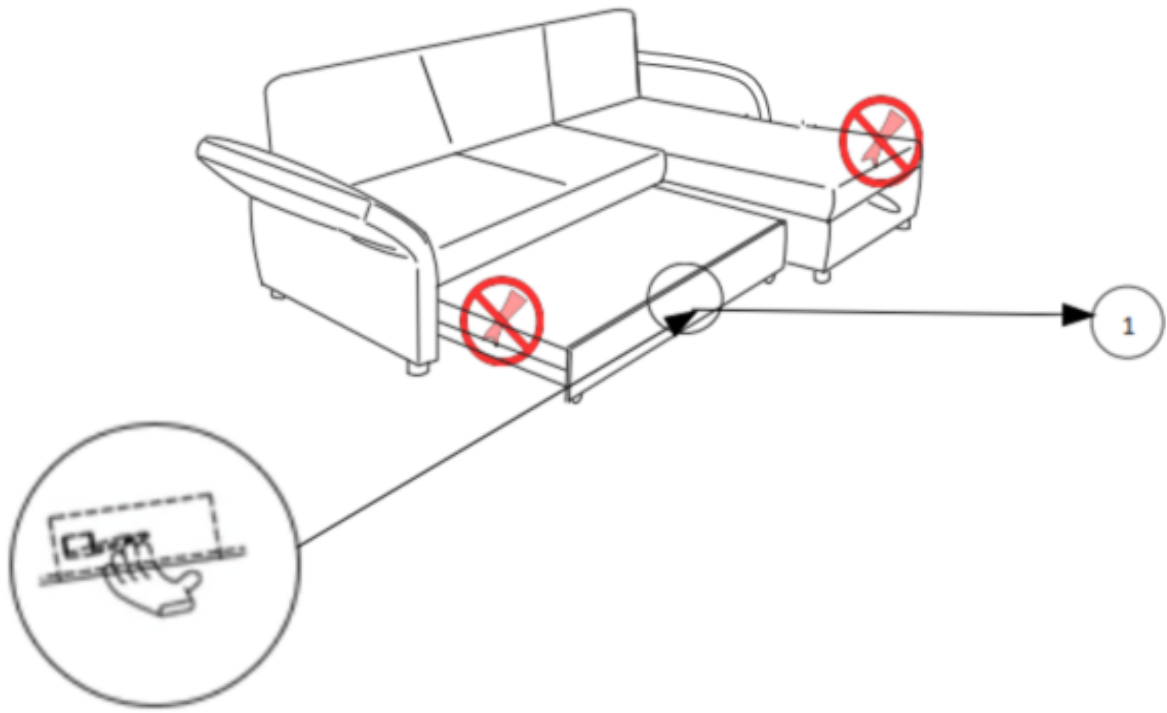

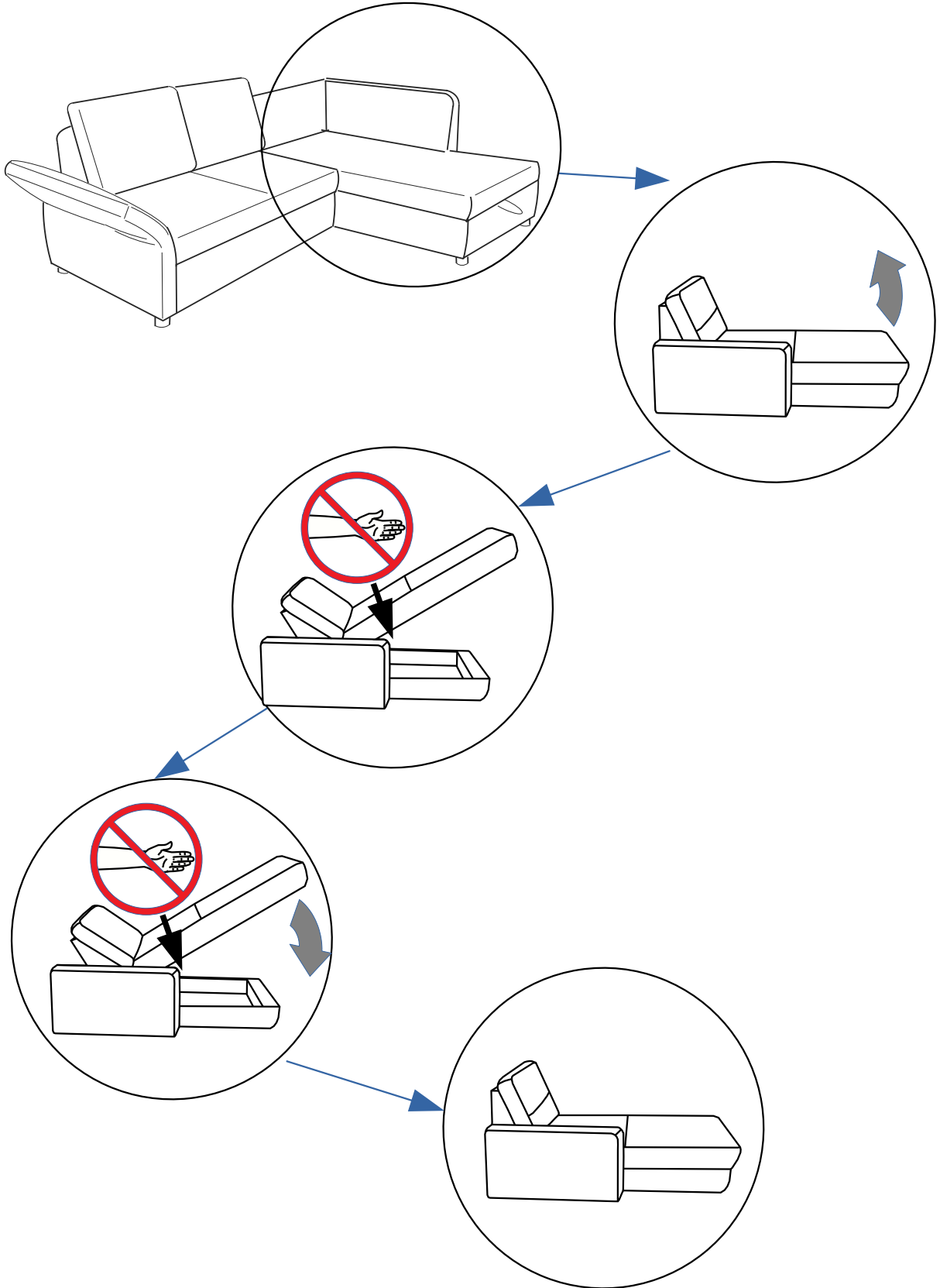

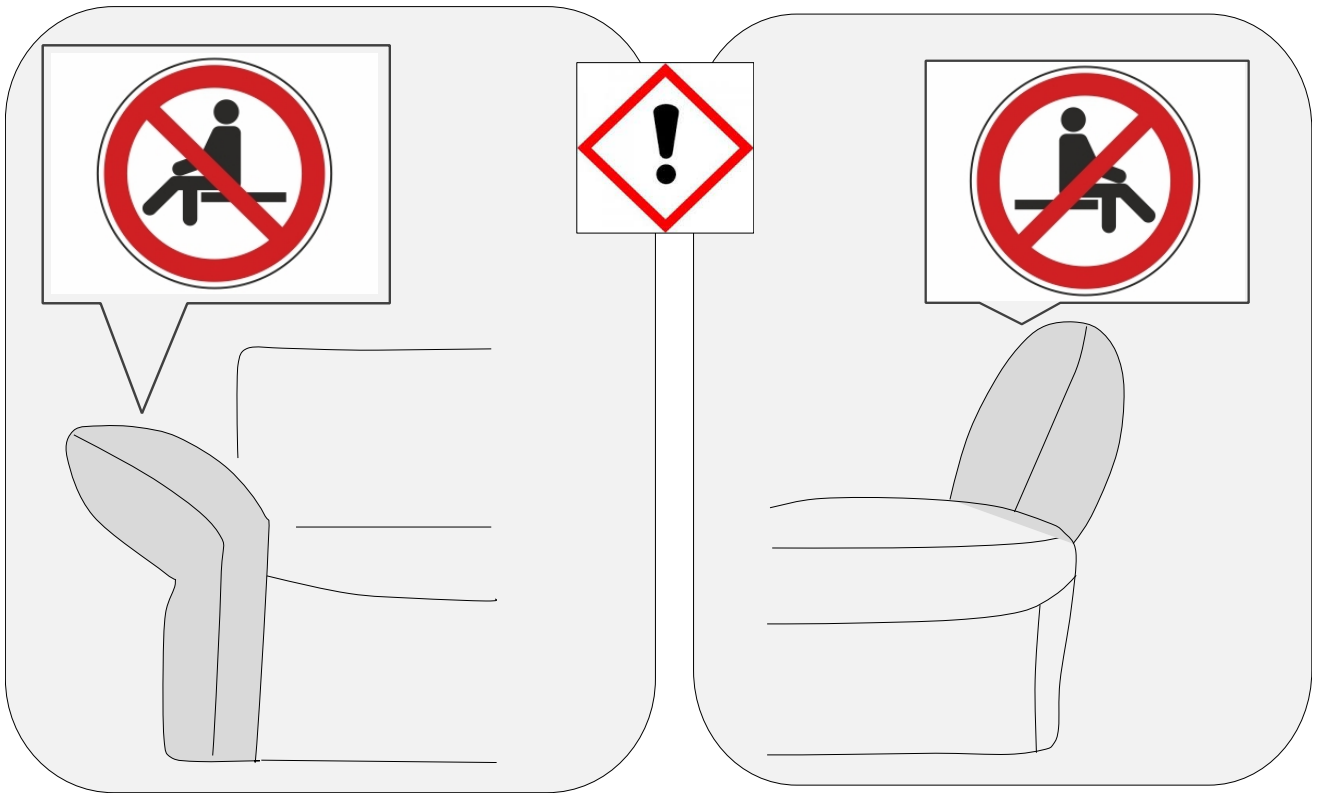
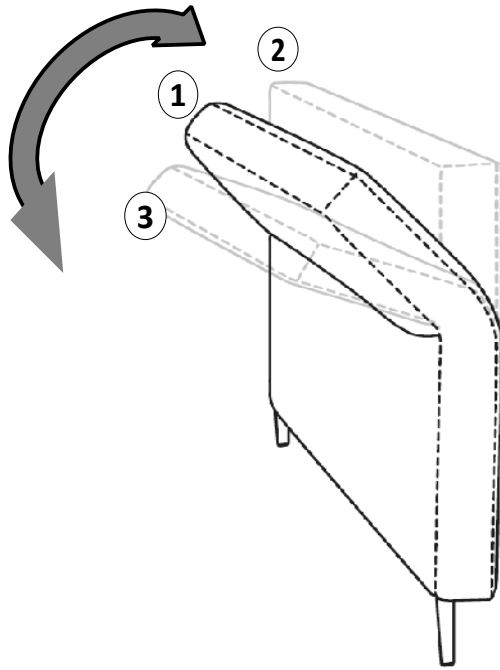

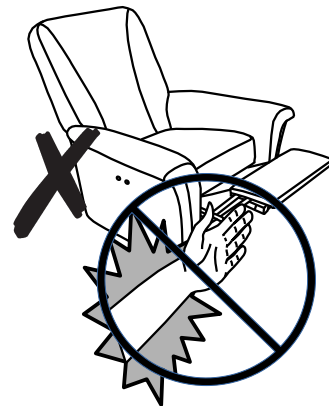
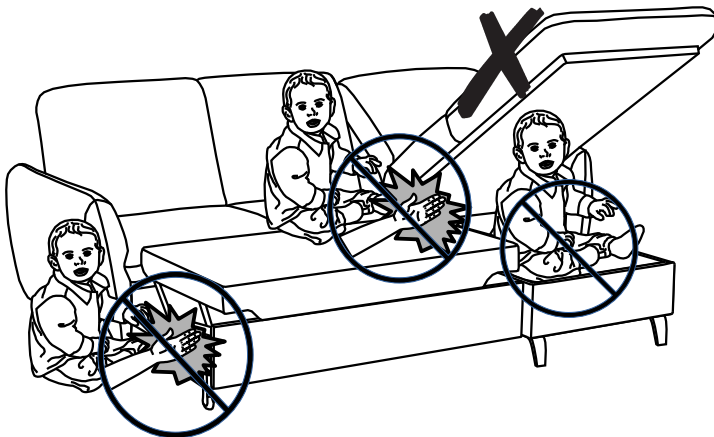
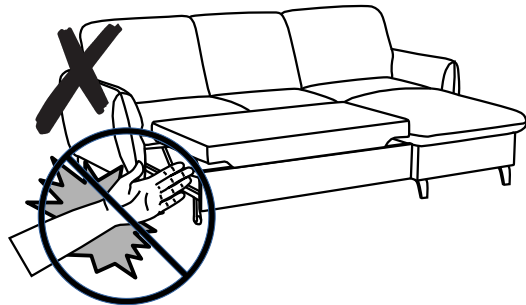
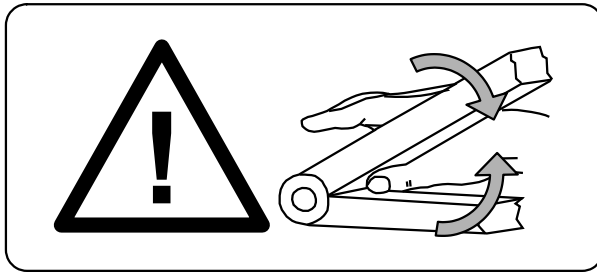
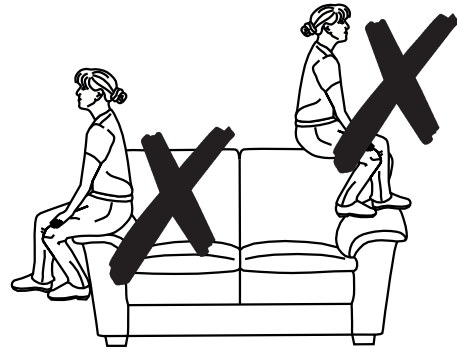
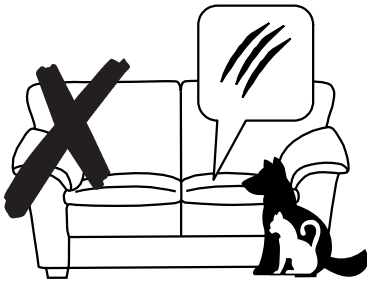
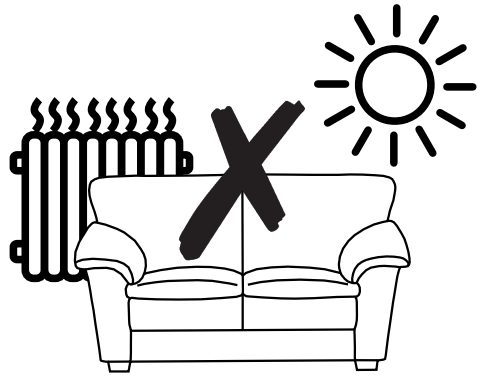

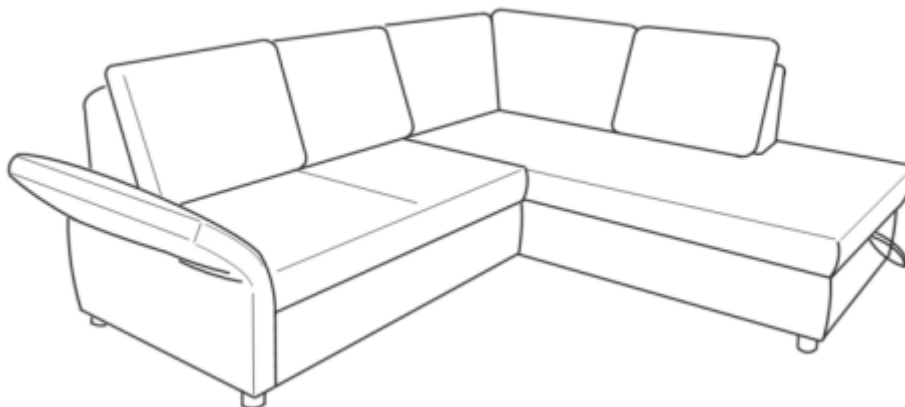
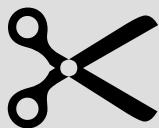
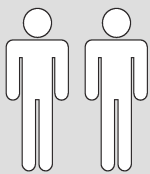

Multiflex Plus Sofa+Ottomane

D

MONTAGEANLEITUNG
BEDIENUNGSANLEITUNG

NL

HANDLEIDING VOOR DE
MONTAGE
GEBRUIKSAANWIJZING

TR

MONTAJ TALIMATI
KULLANIM
KLAVUZU

RO

INSTRUCȚIUNI DE INSTALARE
INSTRUCȚIUNI DE UTILIZARE

FR

NOTICE DE MONTAGE
MANUEL INSTRUCTIONS

HU

KÖZGYŰLÉS UTASÍTÁSOK
KEZELÉSI UTASÍTÁS

SI

NAVODILA ZA MONTAŽO
NAVODILA ZA UPORABO

ES

INSTRUCCIONES DE MONTAJE
MANUAL DEL USUARIO

GB

ASSEMBLY
INSTRUCTIONS
INSTRUCTION MANUAL

PL

INSTRUKCJA
MONTAŻU
INSTRUKCJA OBSŁUGI

RU

ИНСТРУКЦИЯ ПО МОНТАЖУ
ИНСТРУКЦИЯ ПО
ЭКСПЛУАТАЦИИ

IT

ISTRUZIONI DI
MONTAGGIO
MANUALE DI ISTRUZIONI

SK

MONTÁŽNY NÁVOD
NÁVOD NA
POUŽITIE

CZ

MONTÁŽNÍ
NÁVOD
NÁVOD K POUŽITÍ

PT

INSTRUÇÕES DE
MONTAGEM
MANUAL DO USUÁRIO

HR

UPUTE ZA MONTAŽU
UPUTE ZA UPOTREBU

Service · Dienstverlening · Serwis · Servis · Сервисная служба · Serviciu · Services
· Servizio · Servisný list · Szolgáltatás · Servisní list

Name · Naam · Nazwa · Ísim · Название · Nume · Nome · Názov ·
Názov · Název · Neve

Multiflex Plus Sofa + Ottomane

Тип · Type · Tip · Тип · Tipo · Típus

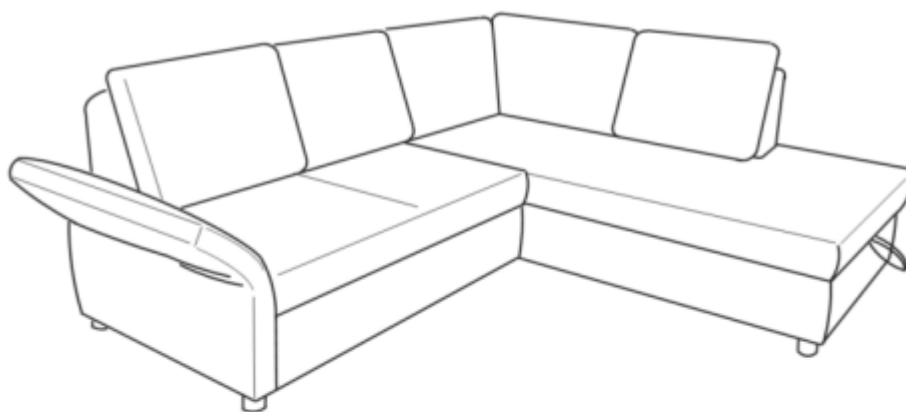
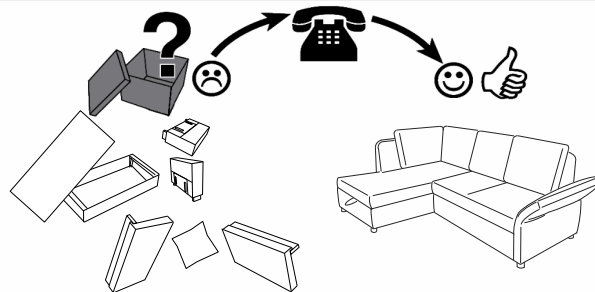
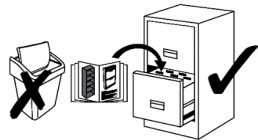

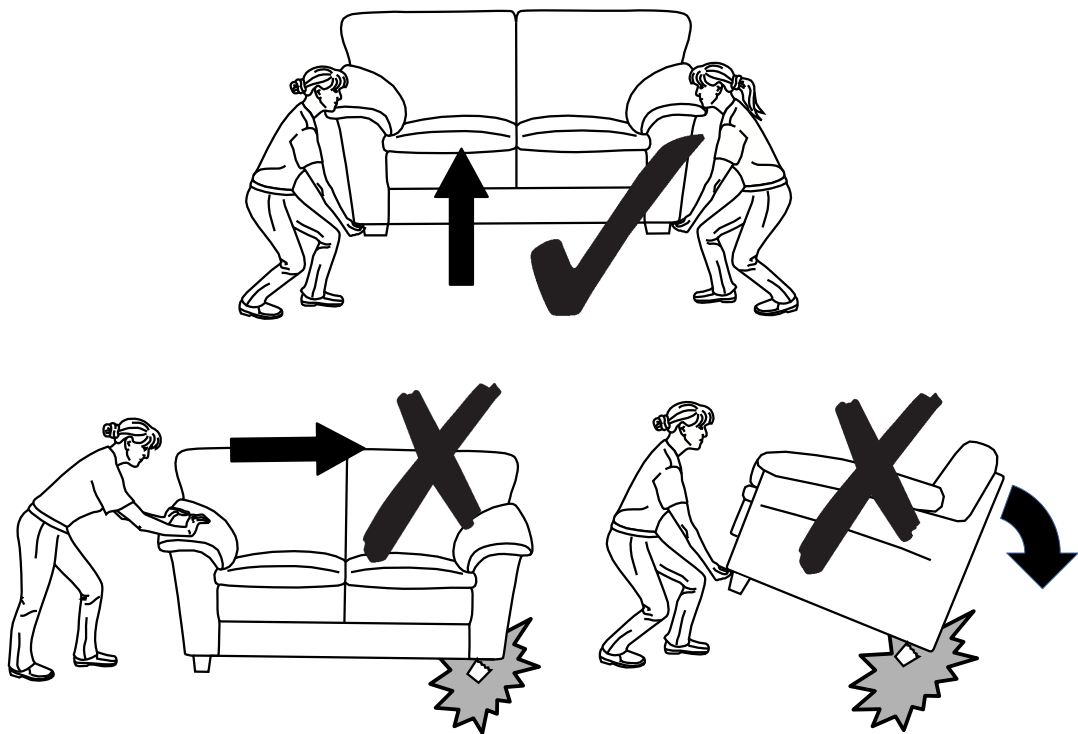
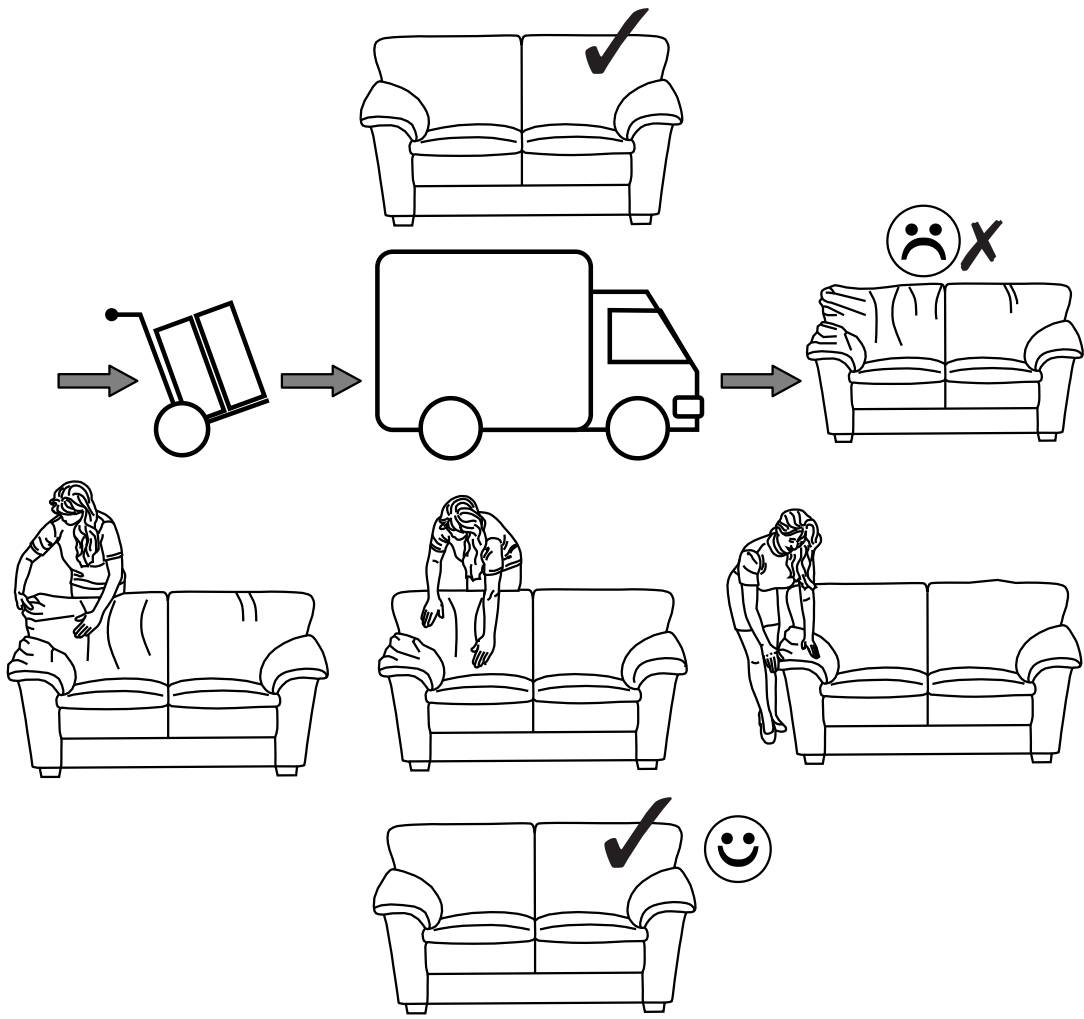

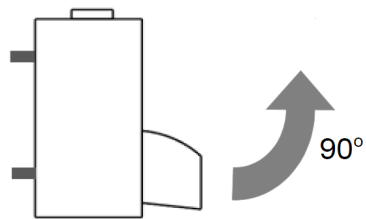
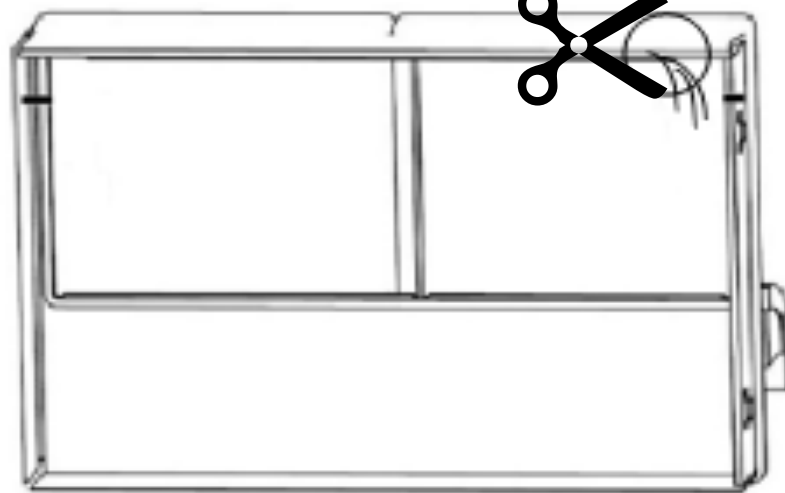
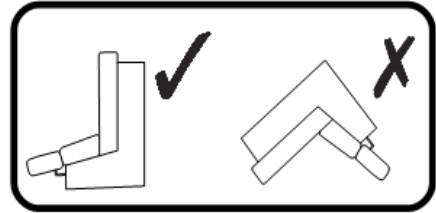
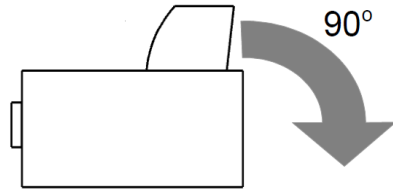
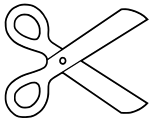

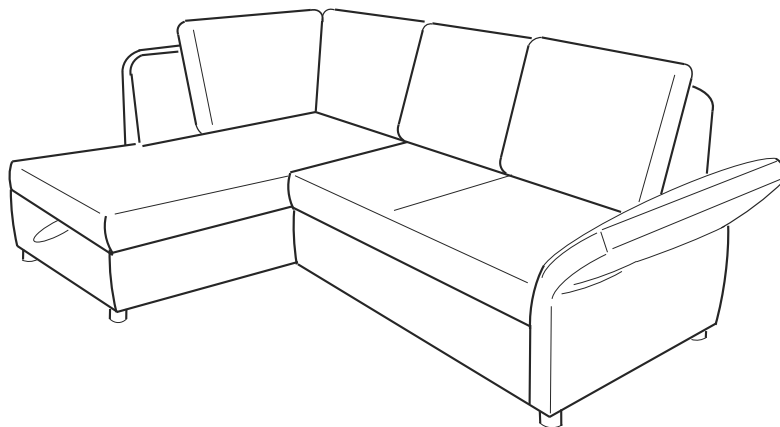
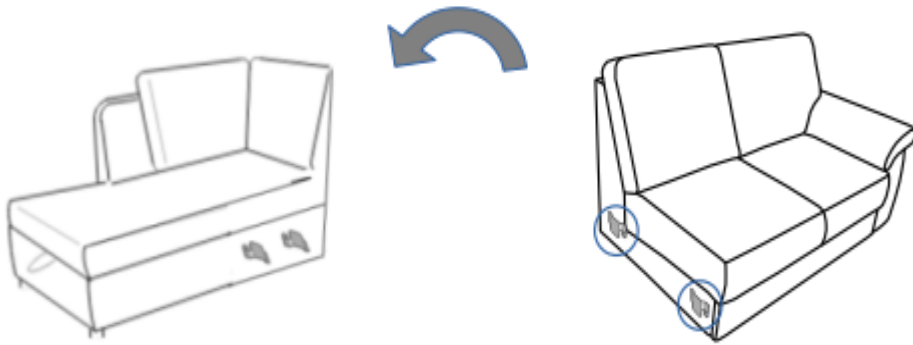
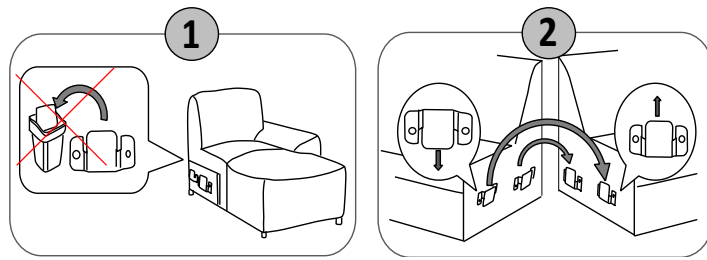

BETTFUNKTION

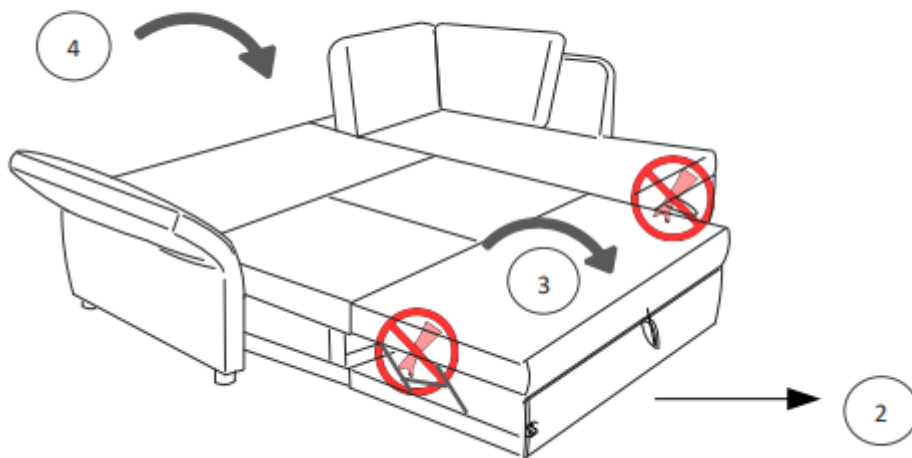
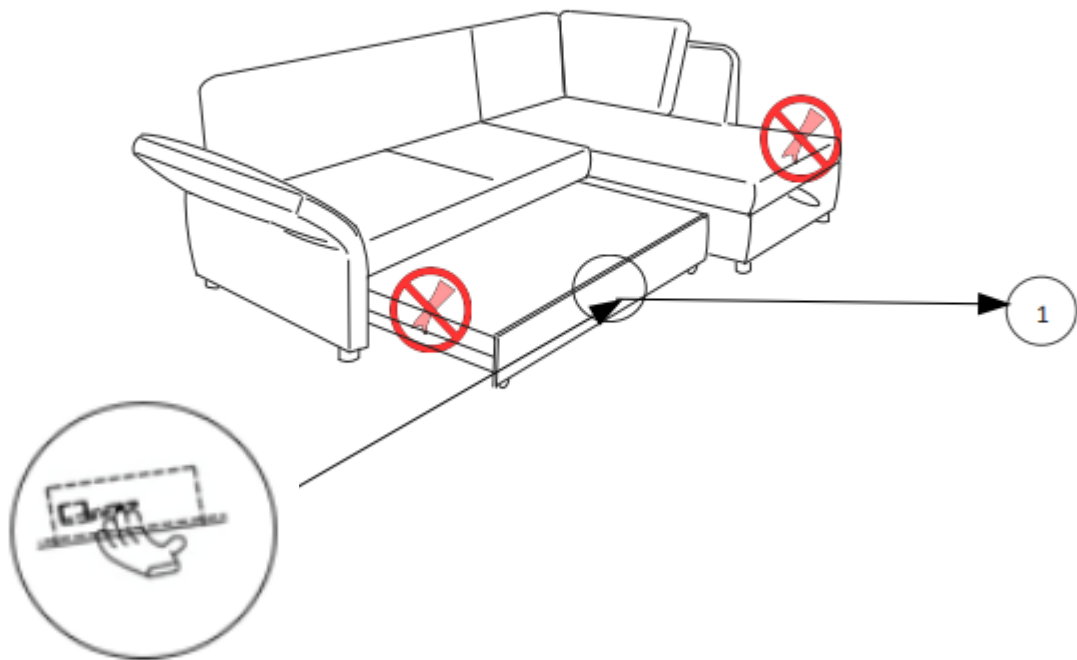

RELAXFUNKTION

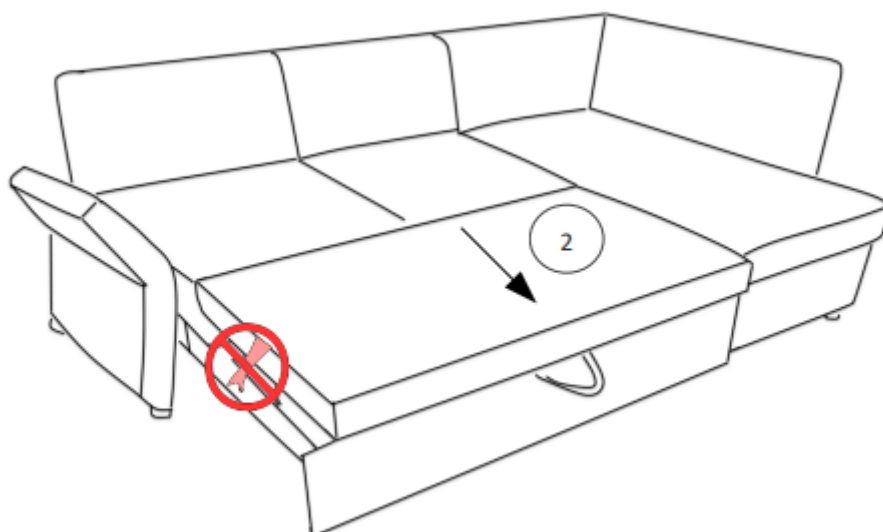
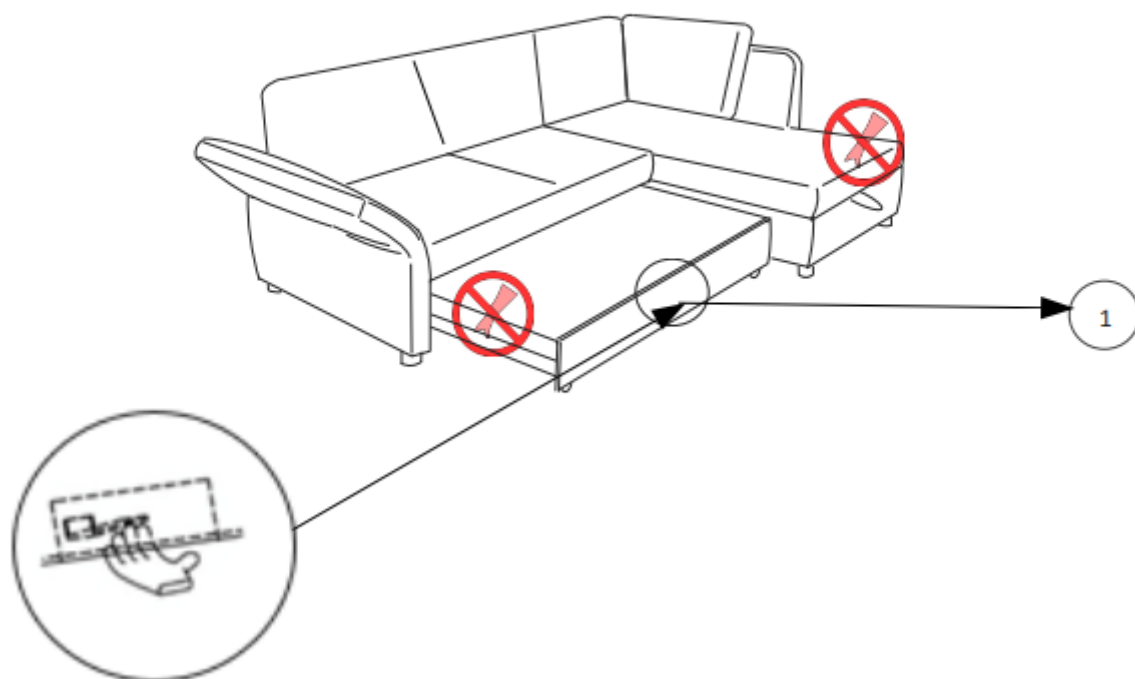

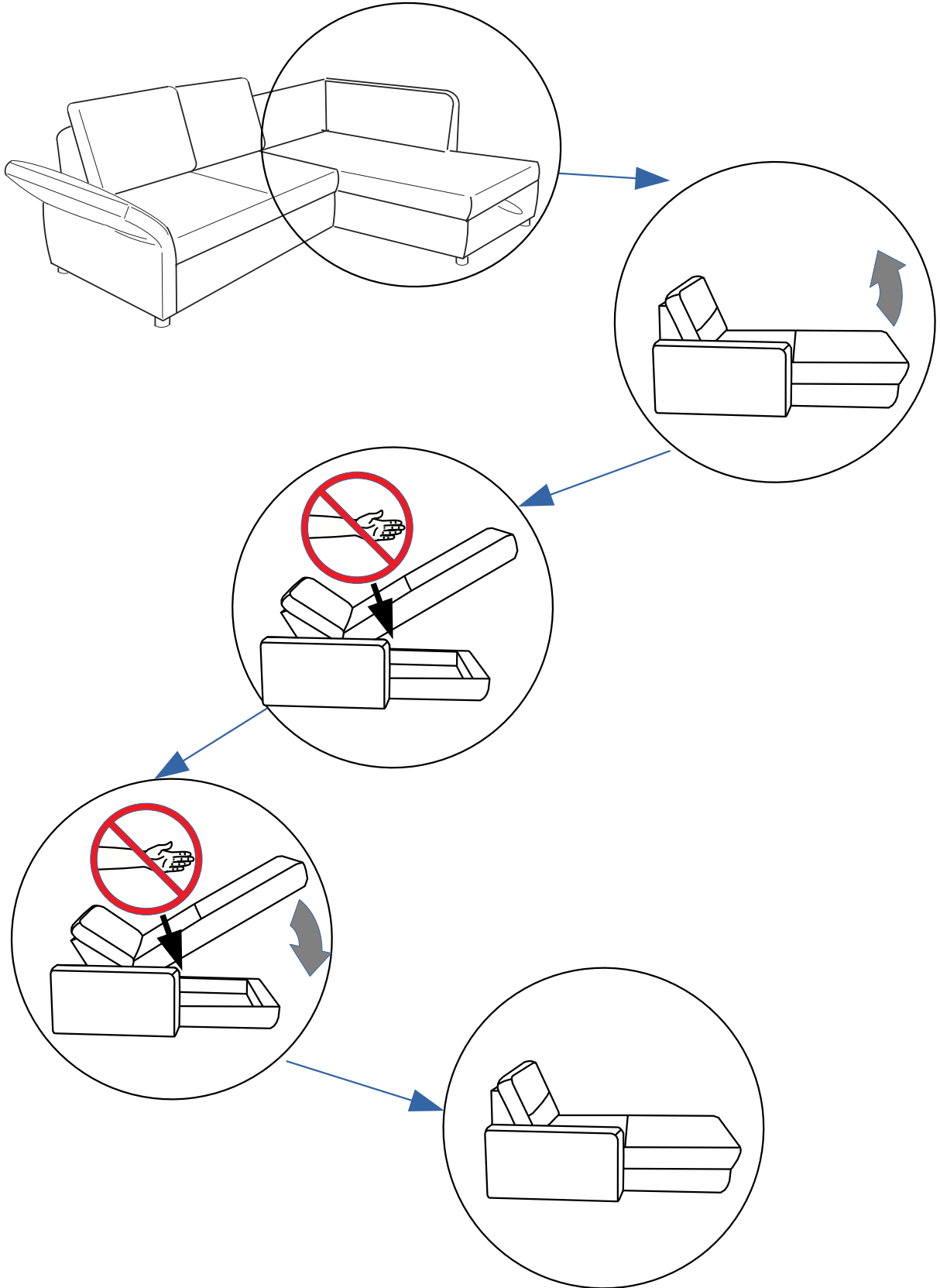

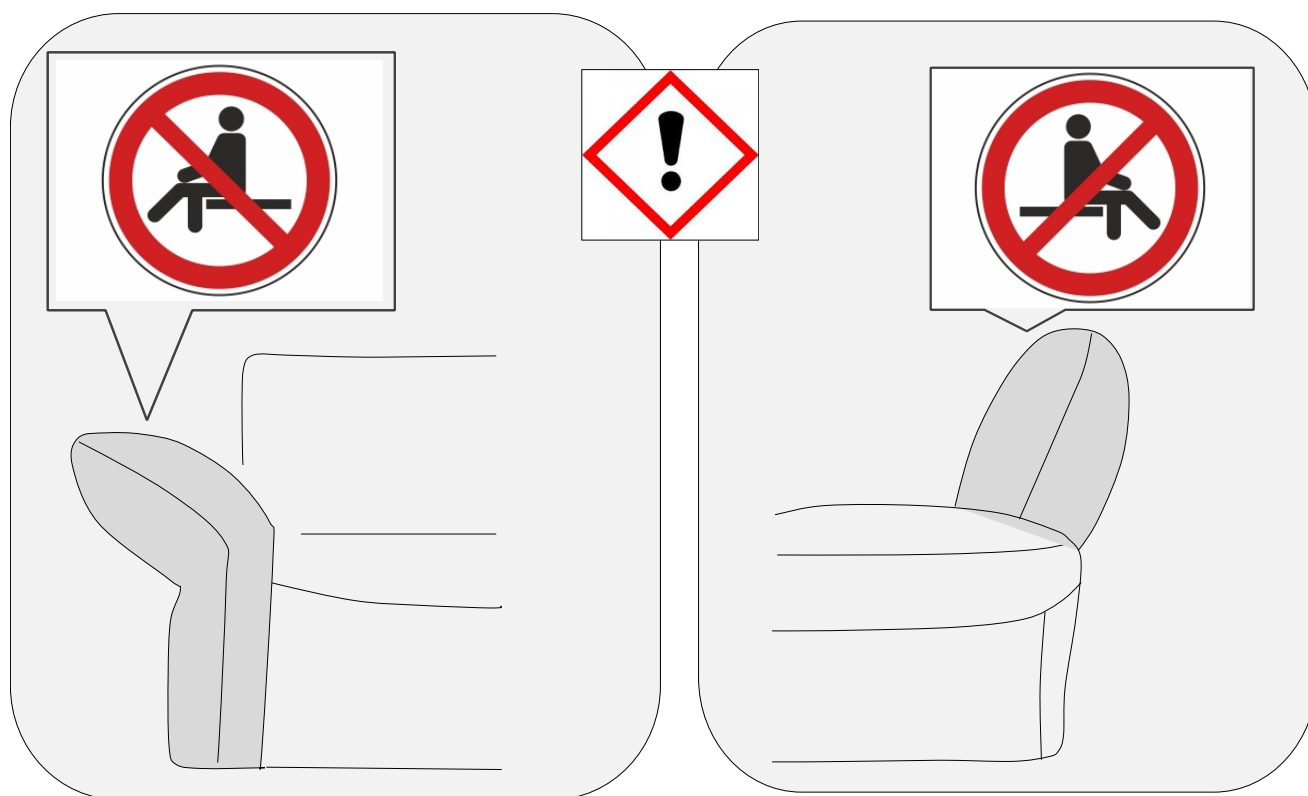
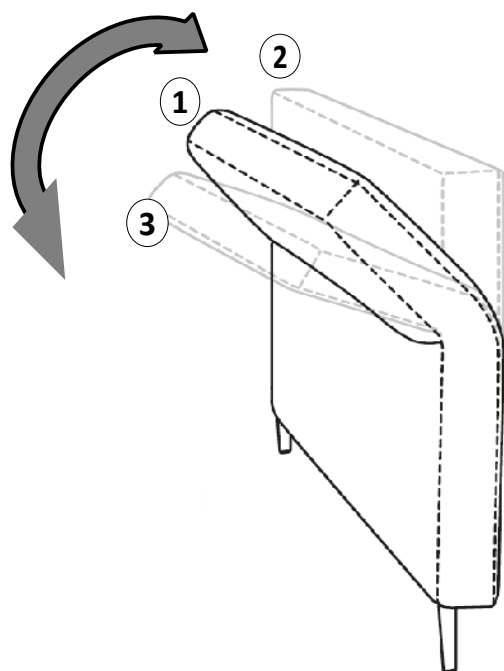

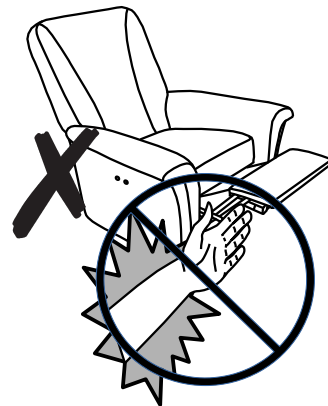
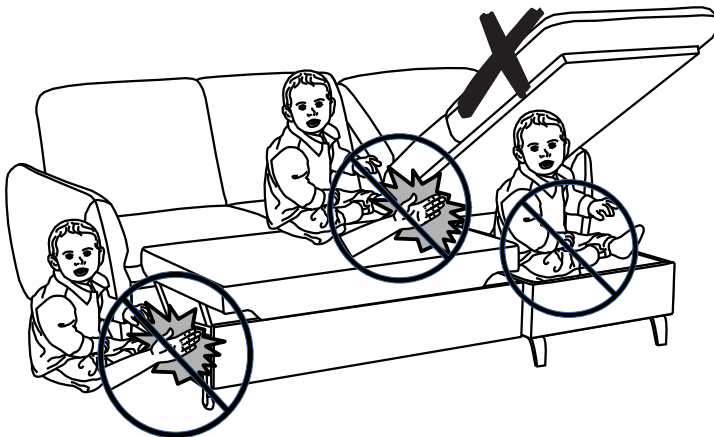
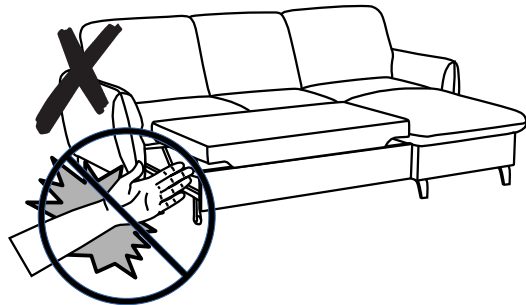
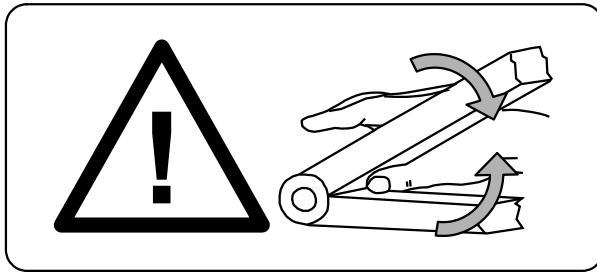
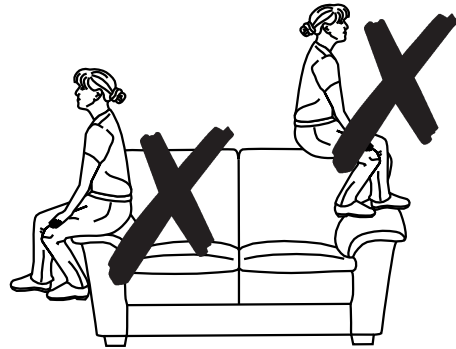
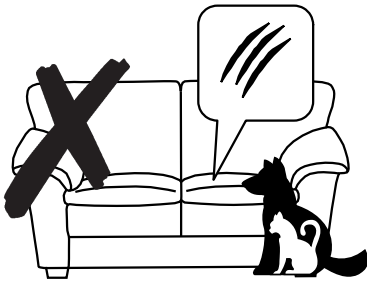
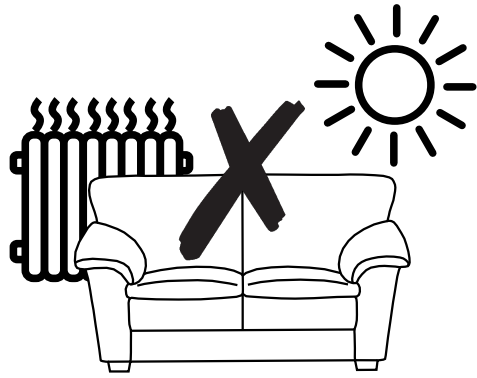

ACHTUNG!

ACHTUNG!

POSITION 1
DIE GERADE ARMLEHNEN
POSITION DIENT NUR FÜR
TRANSPORTZWECKE.

POSITION 2
DIE MITTLERE ARMLEHNEN
POSITION SORGT FÜR EIN
ANGENEHMES SITZGEFÜHL.

POSITION 3
DIE HERUNTERGEKLAPPT
ARMLEHNEN POSITION
ERMÖGLICHT DEN PERFEKTEN
LIEGEKOMFORT.

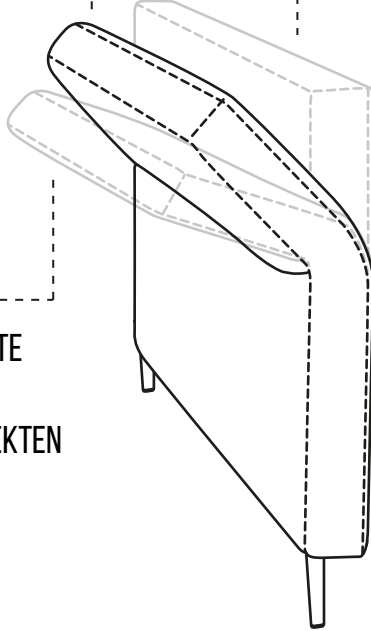

POCO
wunderbar.wandelbar

ACHTUNG!

ACHTUNG!

POSITION 1
DIE GERADE ARMLEHNEN
POSITION DIENT NUR FÜR
TRANSPORTZWECKE.

POSITION 2
DIE MITTLERE ARMLEHNEN
POSITION SORGT FÜR EIN
ANGENEHMES SITZGEFÜHL.

POSITION 3
DIE HERUNTERGEKLAPPT
ARMLEHNEN POSITION
ERMÖGLICHT DEN PERFEKTEN
LIEGEKOMFORT.

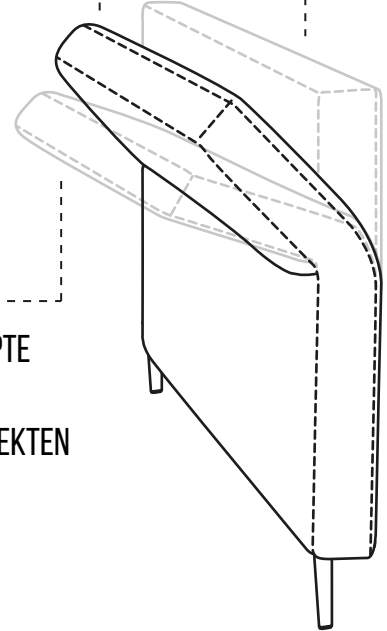

POCO
wunderbar.wandelbar

ACHTUNG!

ACHTUNG!

POSITION 1
DIE GERADE ARMLEHNEN
POSITION DIENT NUR FÜR
TRANSPORTZWECKE.

POSITION 2
DIE MITTLERE ARMLEHNEN
POSITION SORGT FÜR EIN
ANGENEHMES SITZGEFÜHL.

POSITION 3
DIE HERUNTERGEKLAPPT
ARMLEHNEN POSITION
ERMÖGLICHT DEN PERFEKTEN
LIEGEKOMFORT.

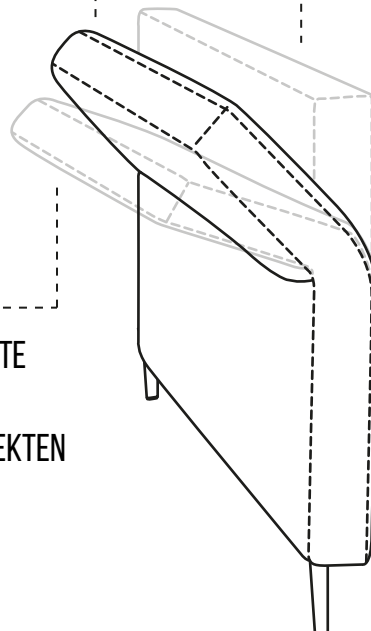

POCO
wunderbar.wandelbar

ACHTUNG!

ACHTUNG!

POSITION 1
DIE GERADE ARMLEHNEN
POSITION DIENT NUR FÜR
TRANSPORTZWECKE.

POSITION 2
DIE MITTLERE ARMLEHNEN
POSITION SORGT FÜR EIN
ANGENEHMES SITZGEFÜHL.

POSITION 3
DIE HERUNTERGEKLAPPT
ARMLEHNEN POSITION
ERMÖGLICHT DEN PERFEKTEN
LIEGEKOMFORT.

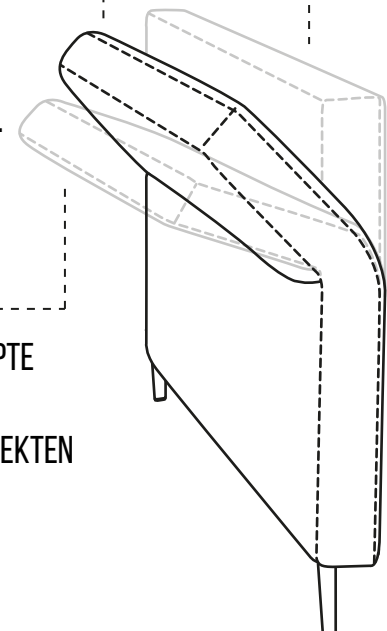

POCO
wunderbar.wandelbar

SCS Sp. z o.o.

Ul. Fabryczna 13

69-110 Rzepin

Polen

poco@steinpol.com.pl