

# GLOBO

LIGHTING

15915-1

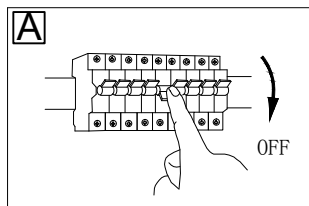

B

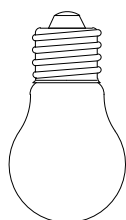
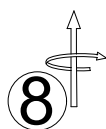
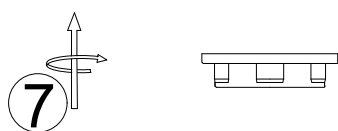
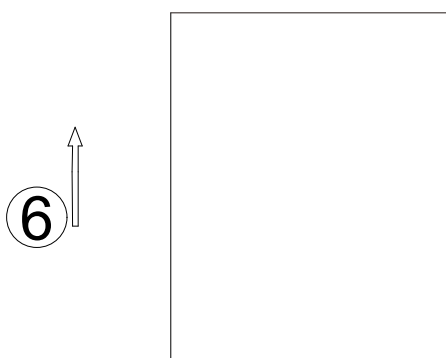
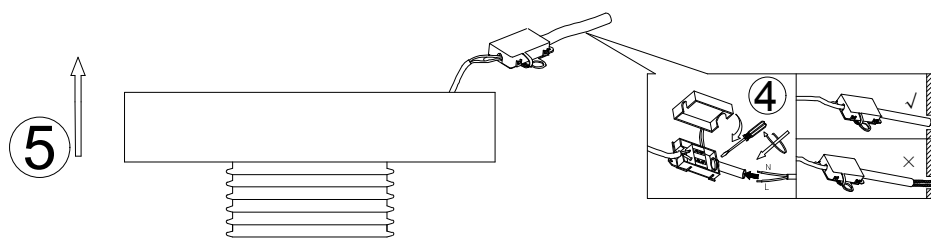
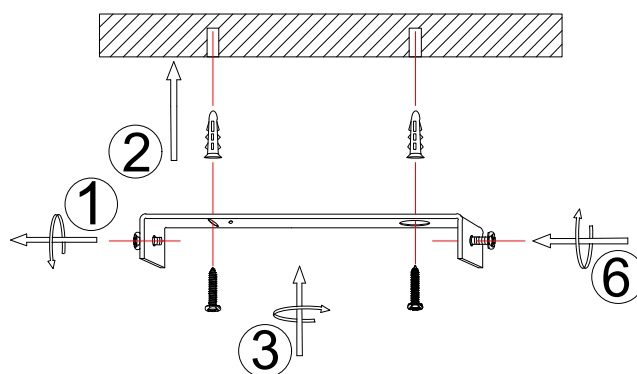

excl.

1x MAX 40W E27  
230V~ 50Hz

GLOBO Handels GmbH  
Gewerbestr. 3  
A-9184 Sankt Peter, Austria  
[www.globo-lighting.com](http://www.globo-lighting.com)  
[office@globo-lighting.com](mailto:office@globo-lighting.com)

