

SMART UP-DOWN

Pendelleuchte / hanging lamp / lampe à suspension / luce a sospensione

Lieferumfang:

Scope of supply:

contenu de la livraison:

consegna:

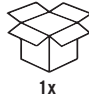

1

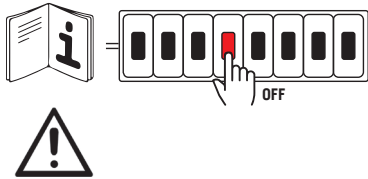

2

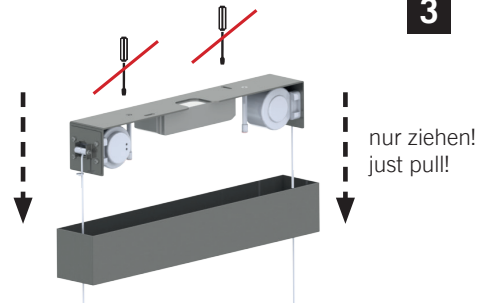

3

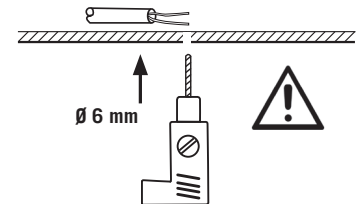

4

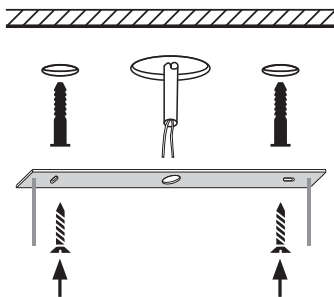

5

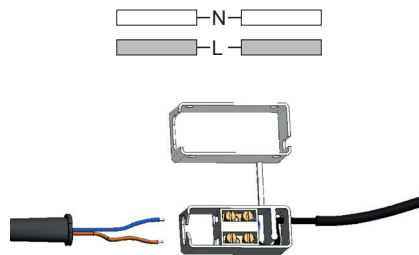

6

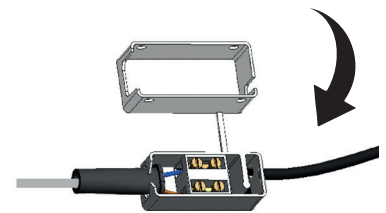

7

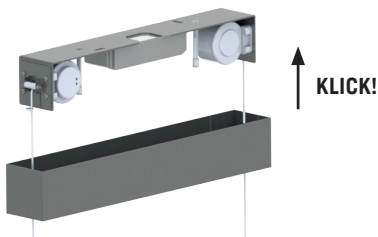

8

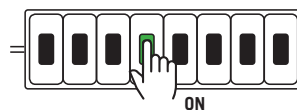

9

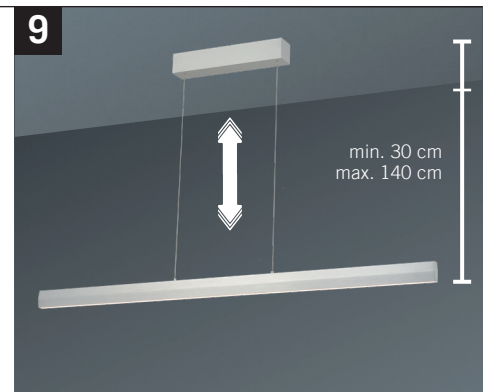

10

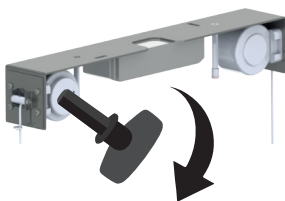

DE Höhenverstellung durch Liftsystem: ab Werk von min. 30 cm bis max. 140 cm. Mit Hilfe des beigegeführten Schlüssels kann die Minimalbegrenzung auf 0 cm verkürzt werden. Hierzu bitte im Gehäuse die Seile am Rollzug nachziehen / nachspannen.

EN Height adjustment by lift system: ex works from min. 30 cm to max. 140 cm. The minimum limit can be reduced to 0 cm using the enclosed key. To do this, please tighten / retension the ropes on the roller hoist in the housing.

FR Réglage de la hauteur par système de levage : départ usine de 30 cm min. à 140 cm max. La limite minimale peut être réduite à 0 cm à l'aide de la clé fournie. Pour ce faire, veuillez resserrer / retendre les câbles du chariot de traction dans le boîtier.

IT Regolazione dell'altezza tramite sistema di sollevamento: funziona da un minimo di 30 cm a un massimo di 140 cm. Il limite minimo può essere ridotto a 0 cm utilizzando la chiave in dotazione. A tal fine, serrare/ritensionare i funi del paranco a rulli nell'alloggiamento.



SMART UP-DOWN

Pendelleuchte / hanging lamp / lampe à suspension / luce a sospensione

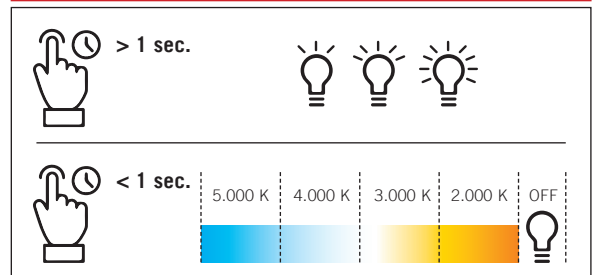
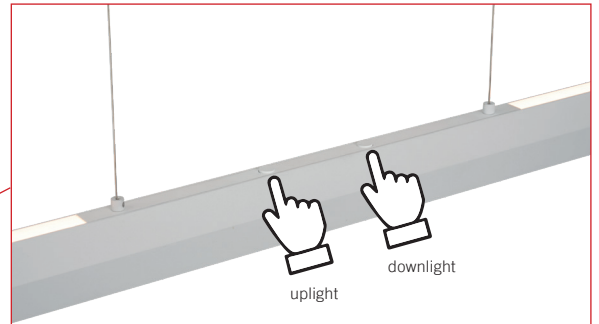
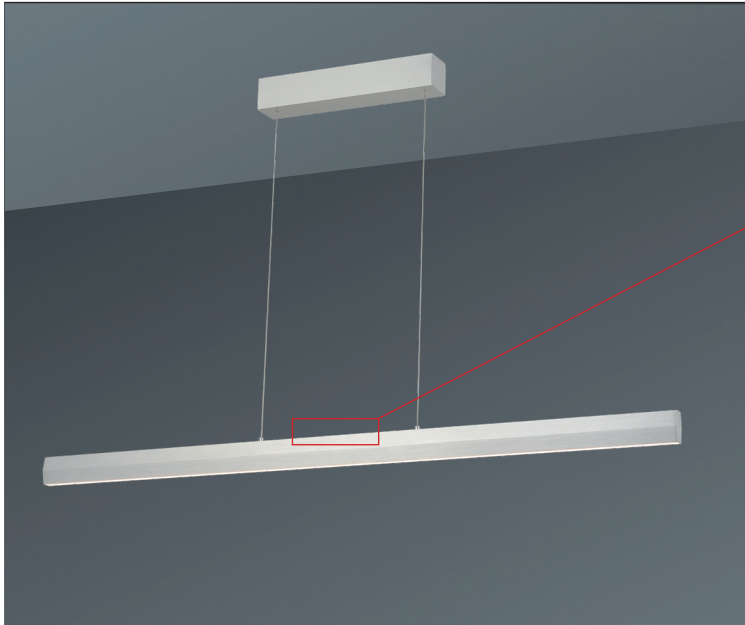

Technische Angaben / technical data / specifications techniques / specifiche tecniche

10/2025

Art. Nr.: 226 602 00 / 228 602 00 / 327 602 00 / 328 602 00

230V ~ 50Hz; LED-Band, 45 W; 4.950 lm - 2.000 K / 5.400 lm - 5.000 K; Ra90

Art. Nr.: 226 902 00 / 228 902 00 / 327 902 00 / 328 902 00

230V ~ 50Hz; LED-Band, 55 W; 6.050 lm - 2.000 K / 6.600 lm - 5.000 K; Ra90



LINUS BOPP LEUCHTEN GMBH · Tannenweg 6 · D - 74838 Limbach · www.bopp-leuchten.de

BEI FRAGEN / IN CASE OF QUESTIONS / EN CAS DE QUESTIONS / PER LE DOMANDE: vk@bopp-leuchten.de · 0049 62 87 / 92 06 0