

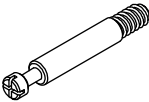

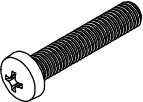





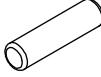
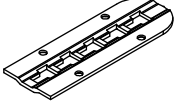

111	8			404	4		M5 x 30 mm
122	8			488	12		
190	12		∅ 8 x 30 mm	707	2		
307	12		6,3 x 15 mm	708	1		
319	12		4 x 50 mm	709	2		
351	12		3,5 x 15 mm	786	4		
352	8		4 x 20 mm	883	6		
372	4		4 x 20 mm				

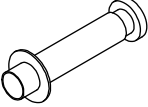
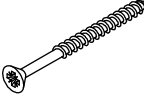

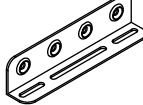

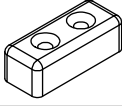

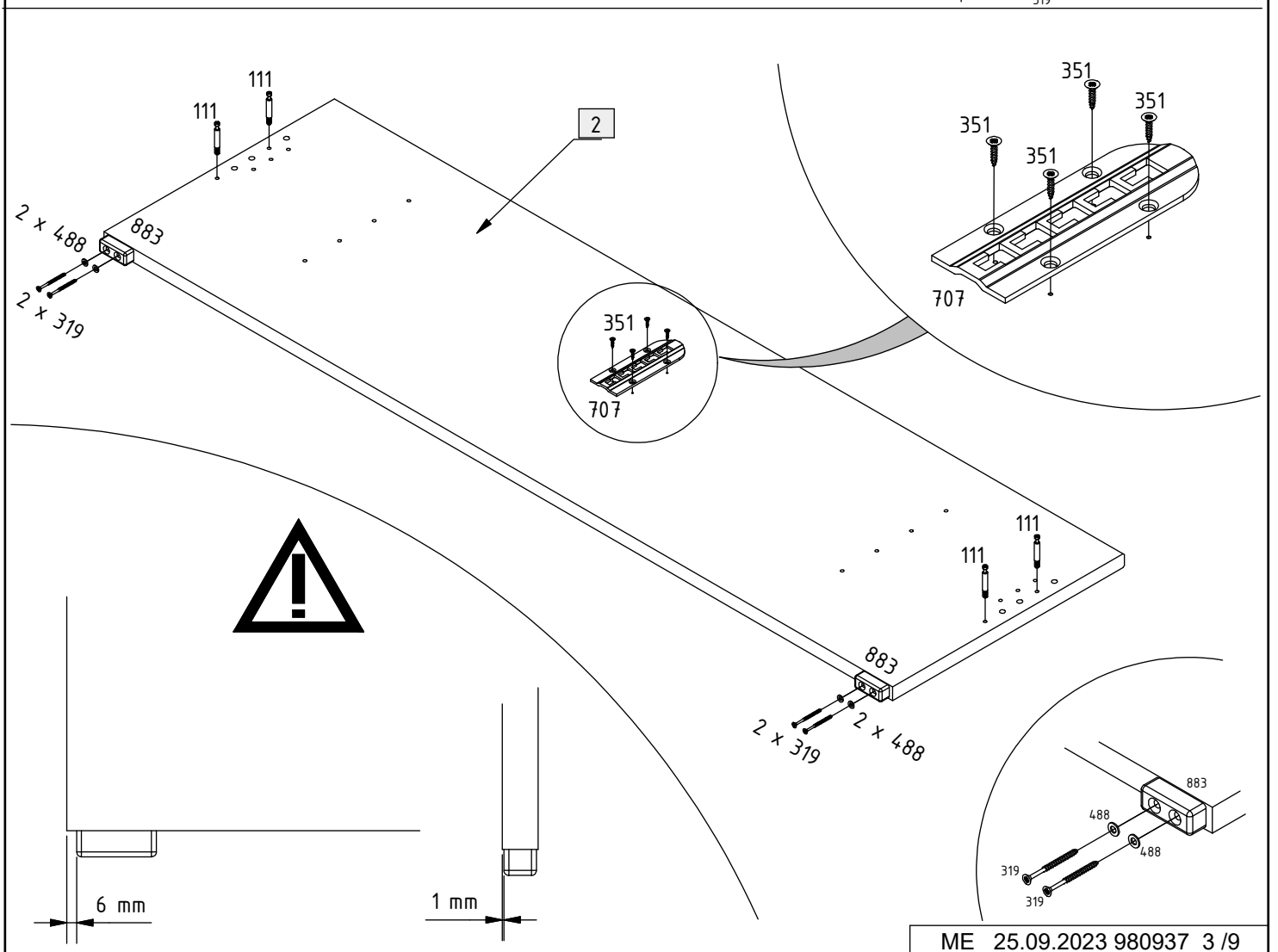
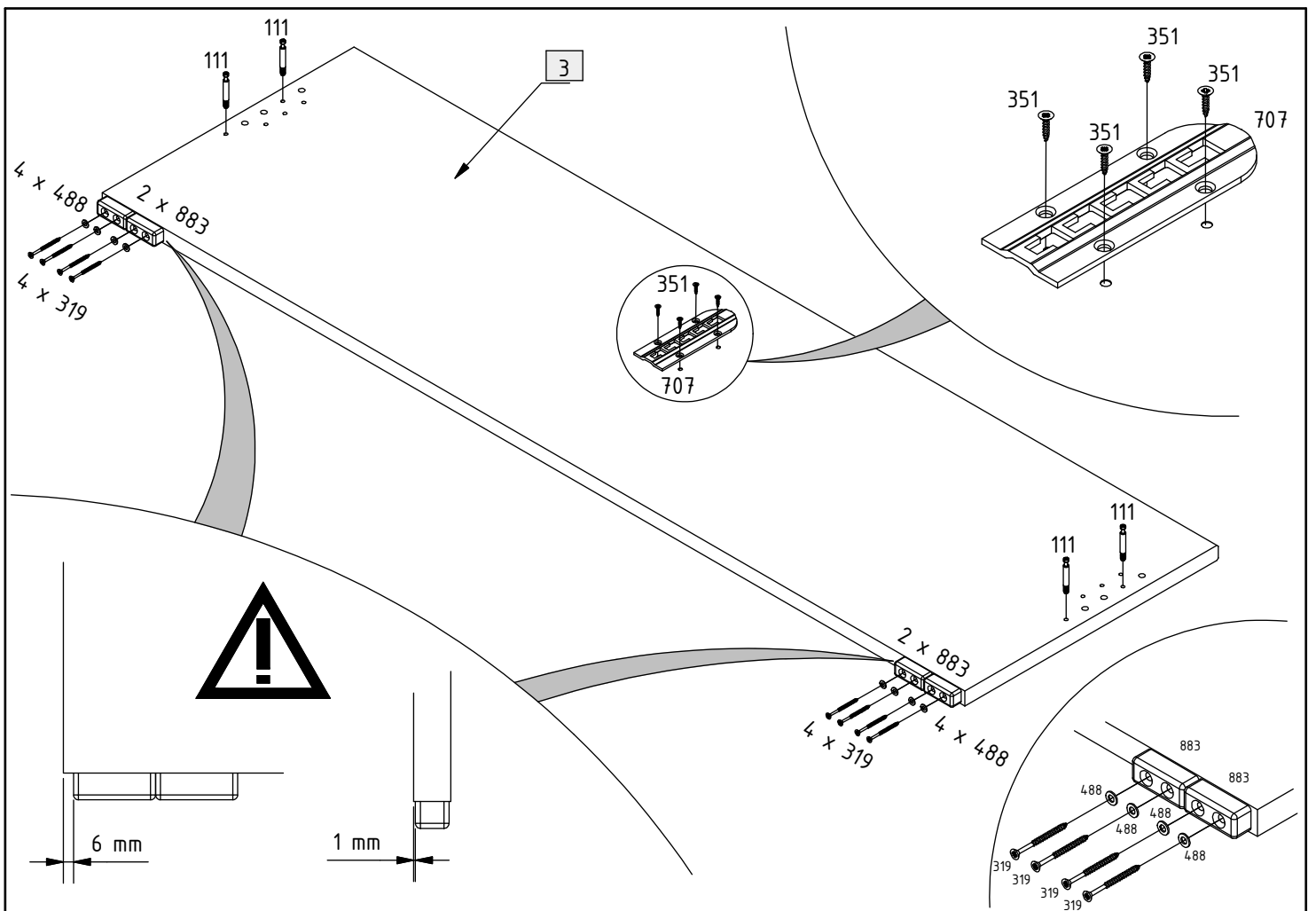
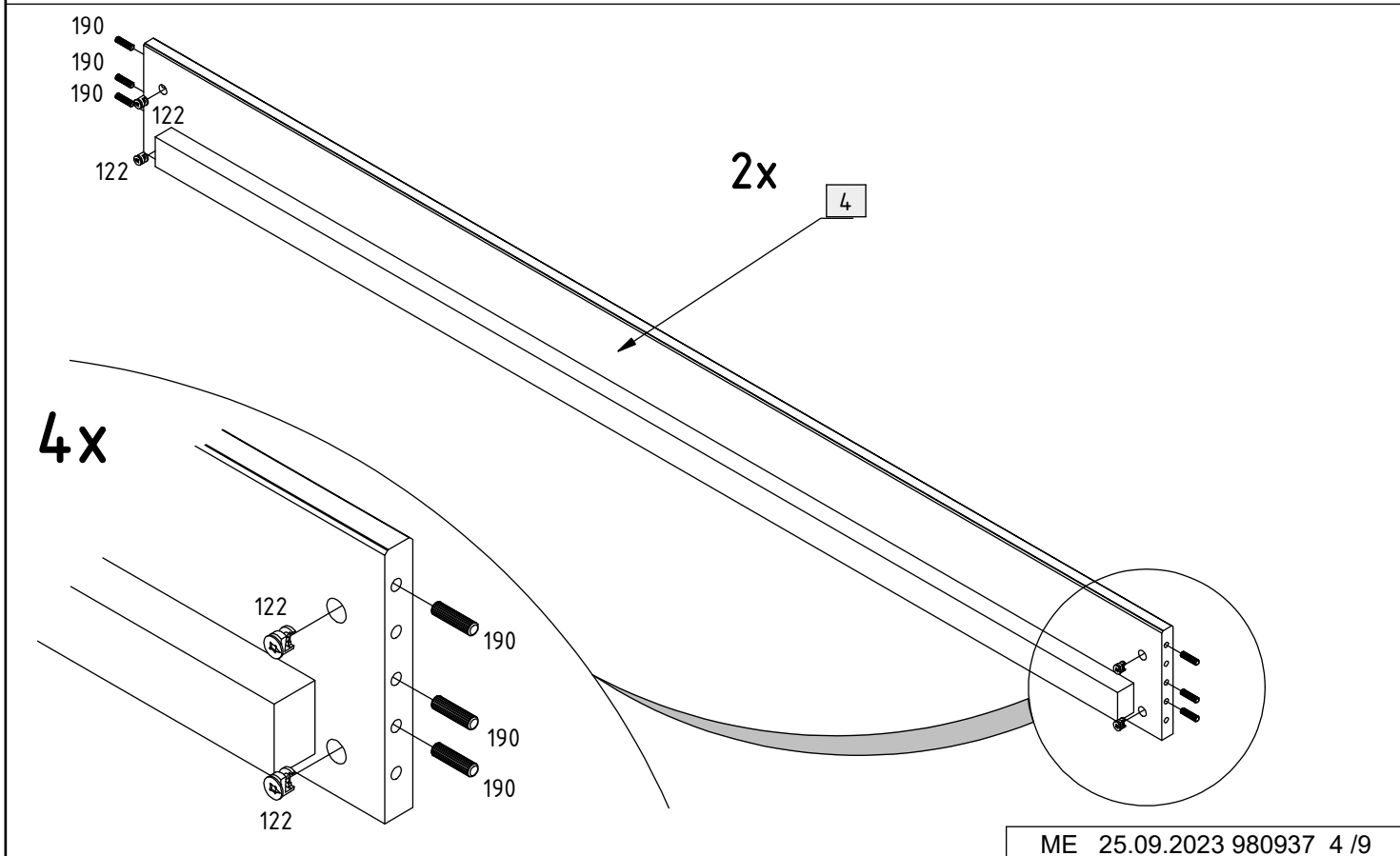
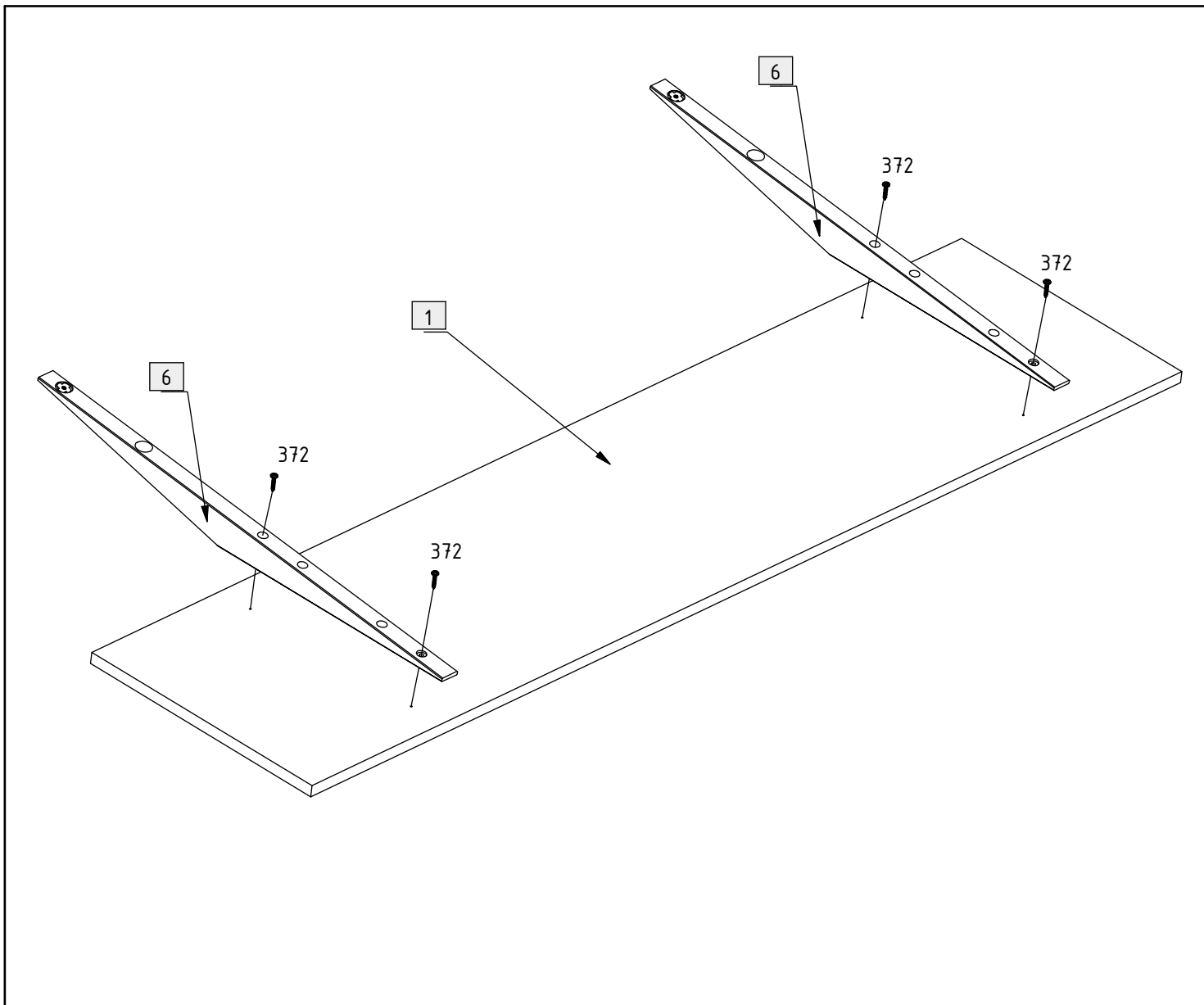
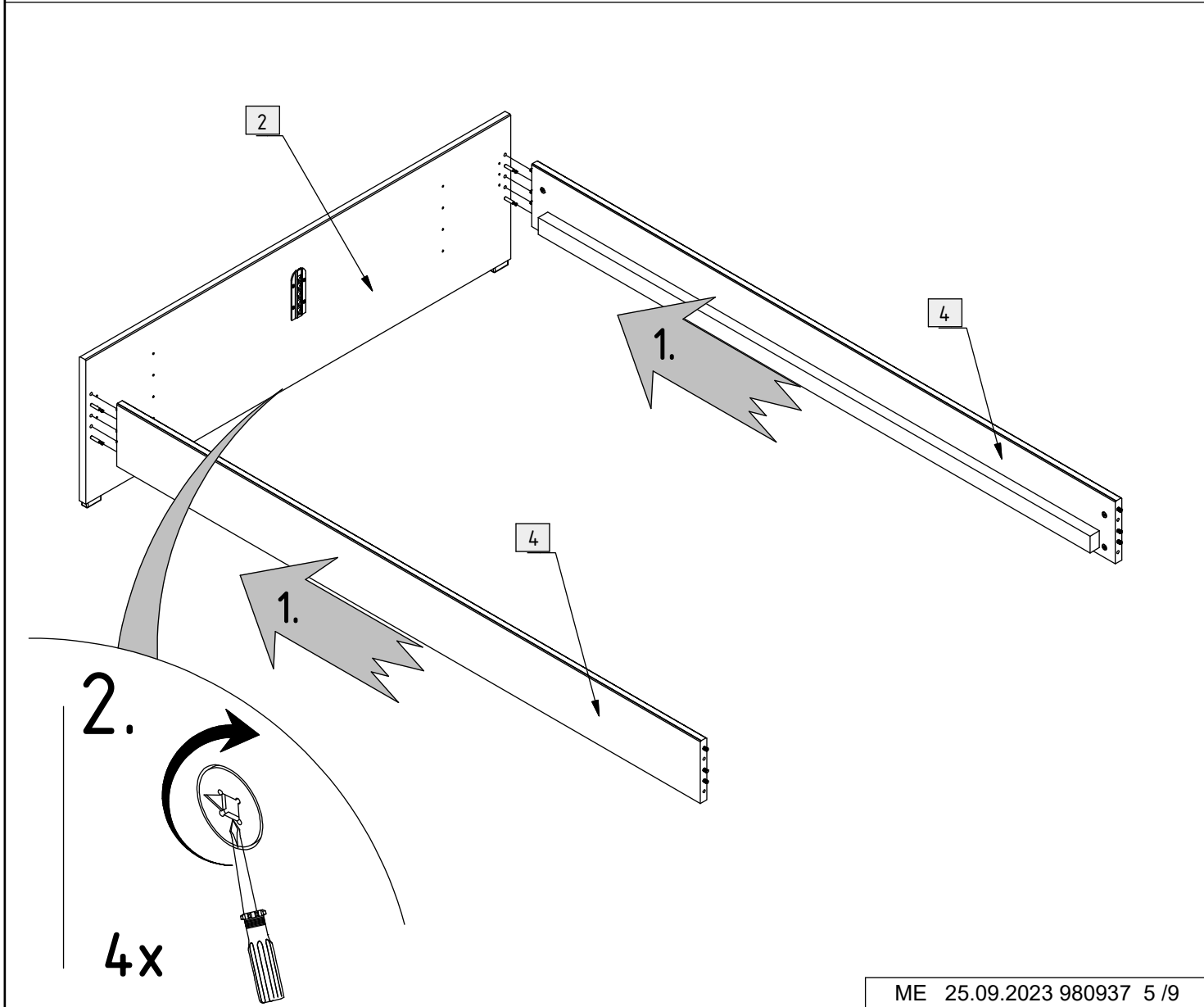
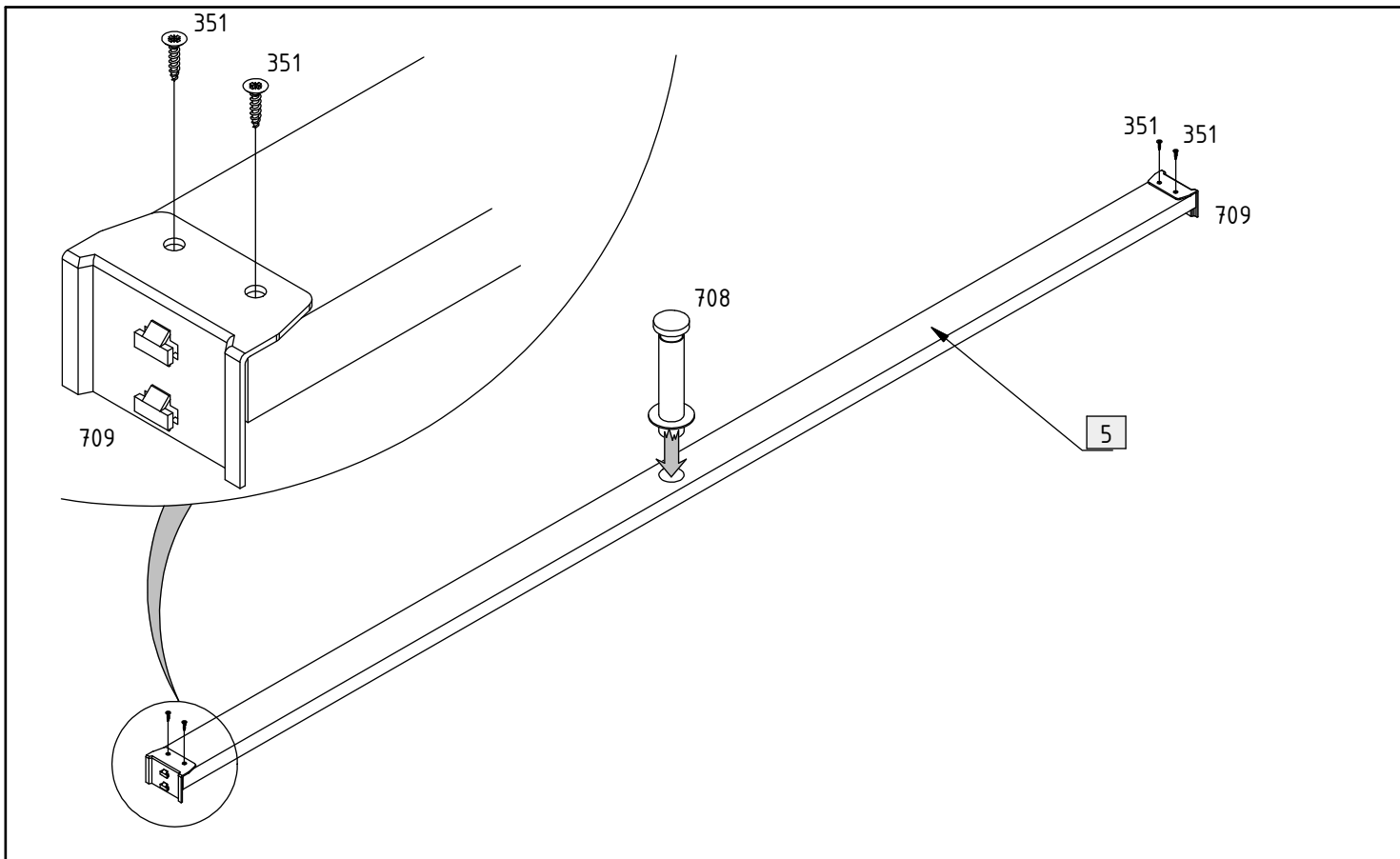
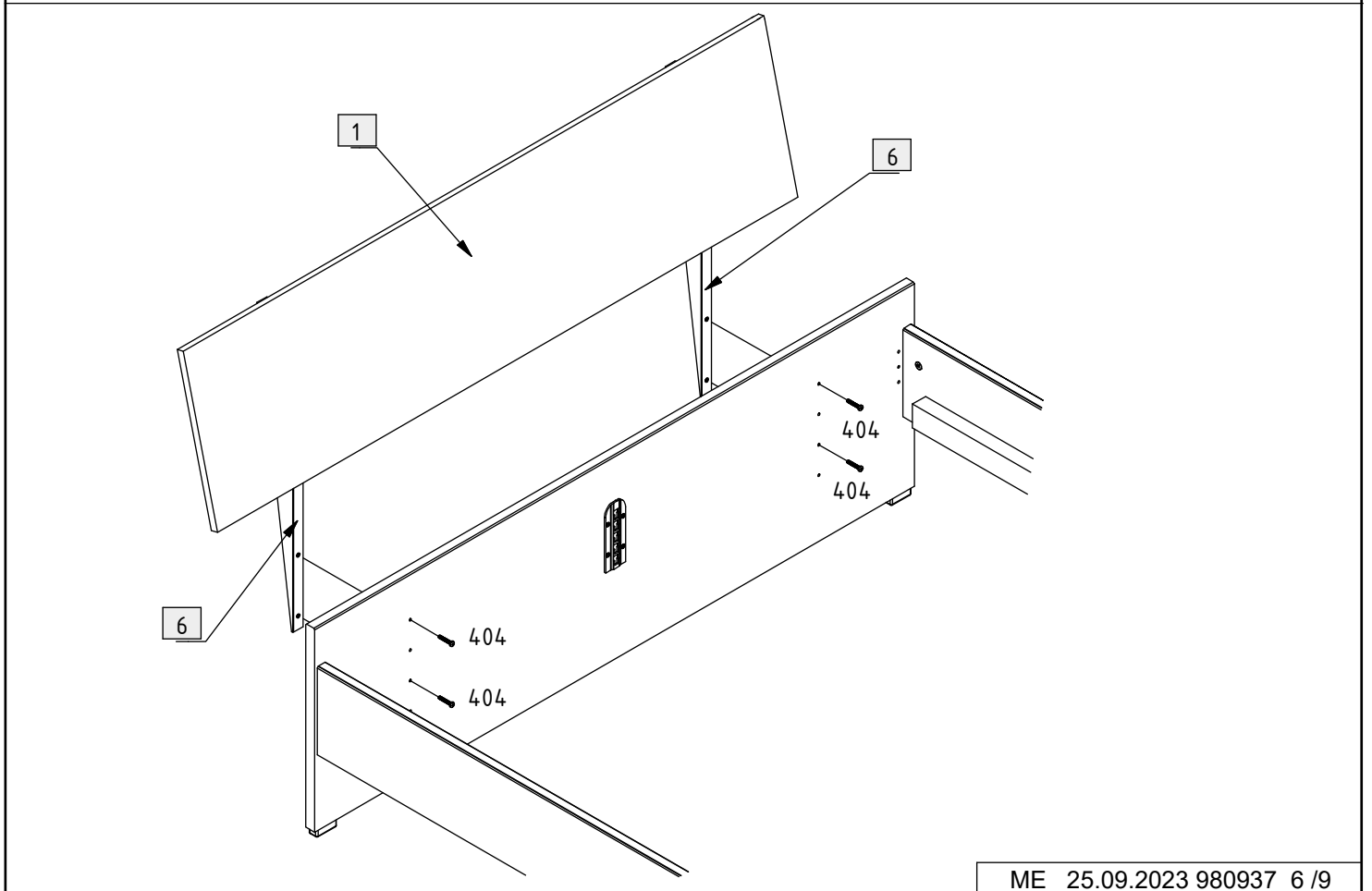
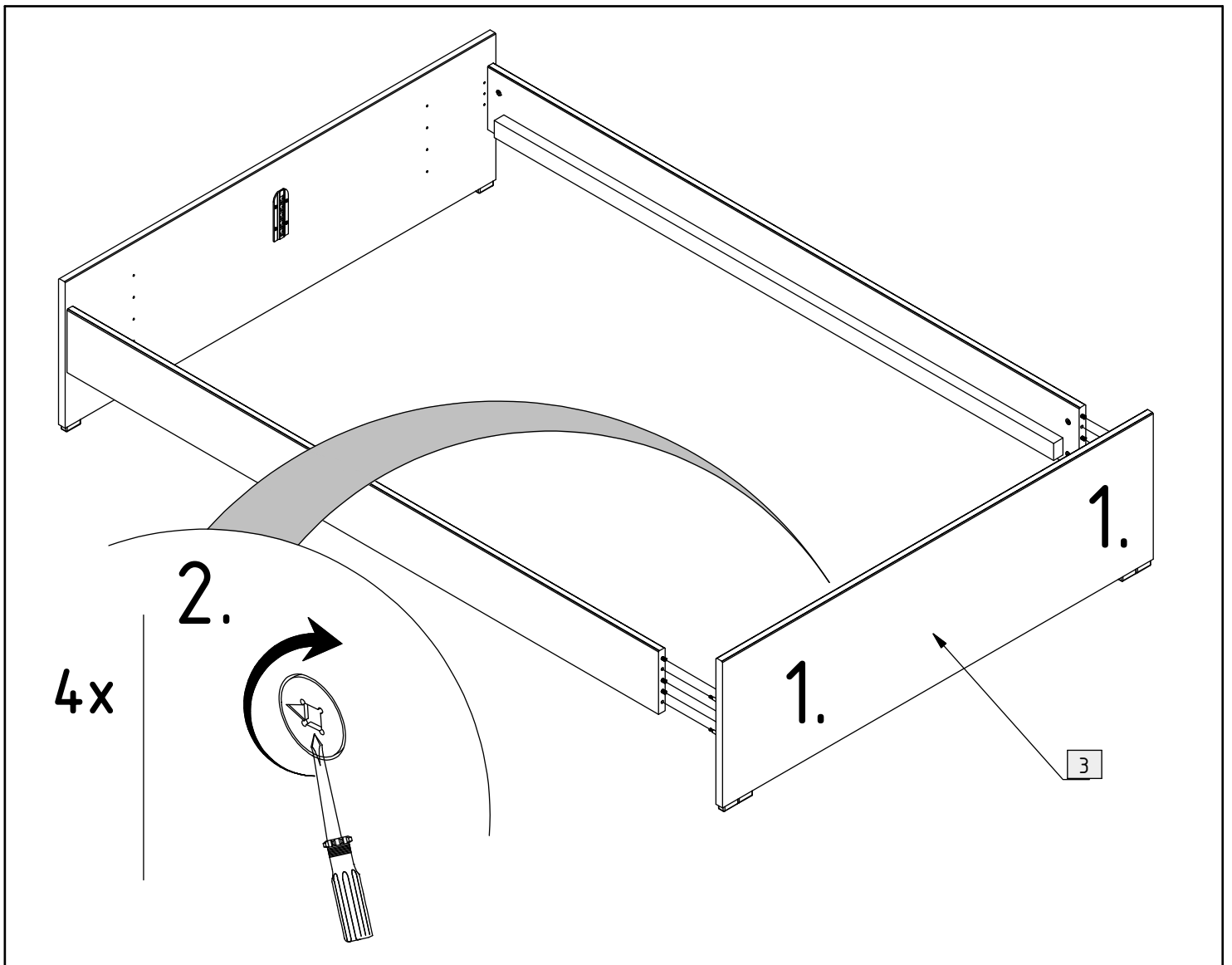

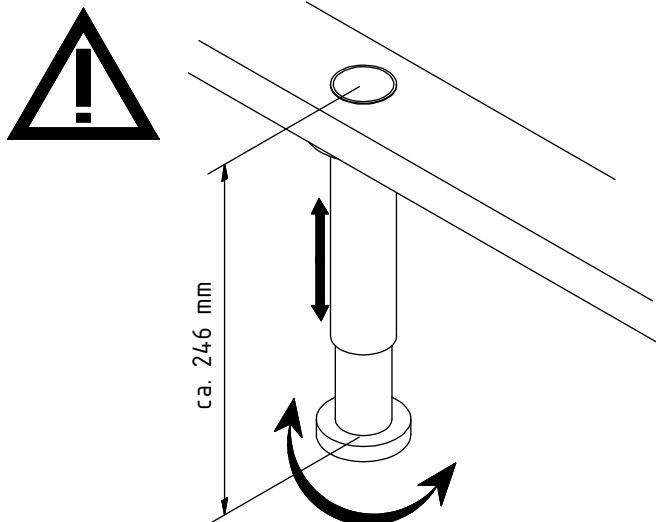
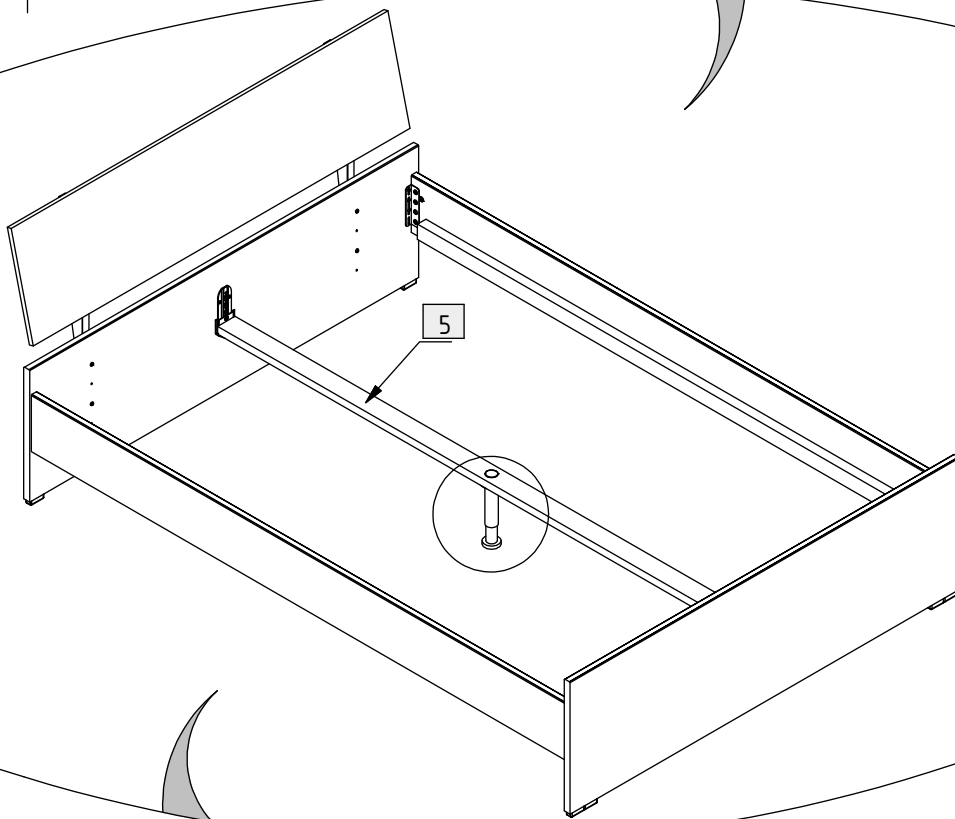
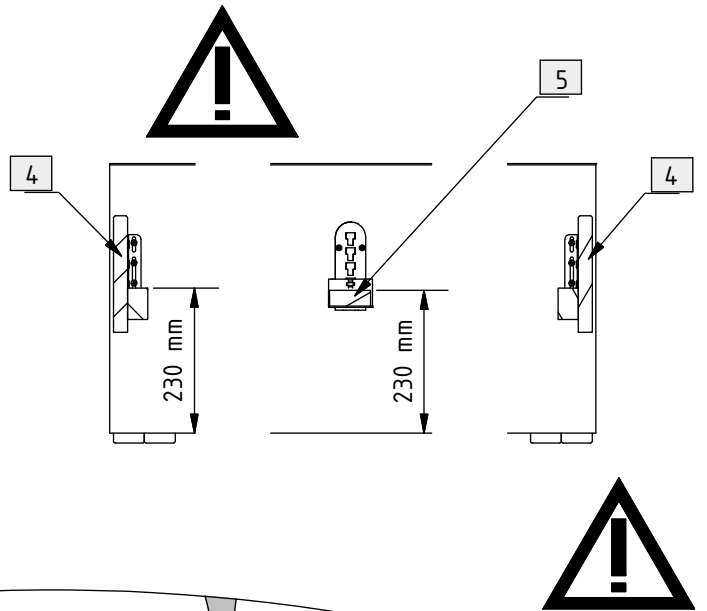
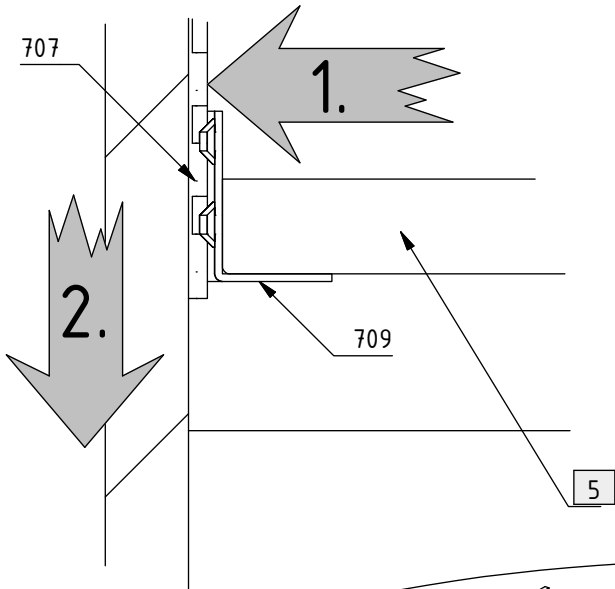

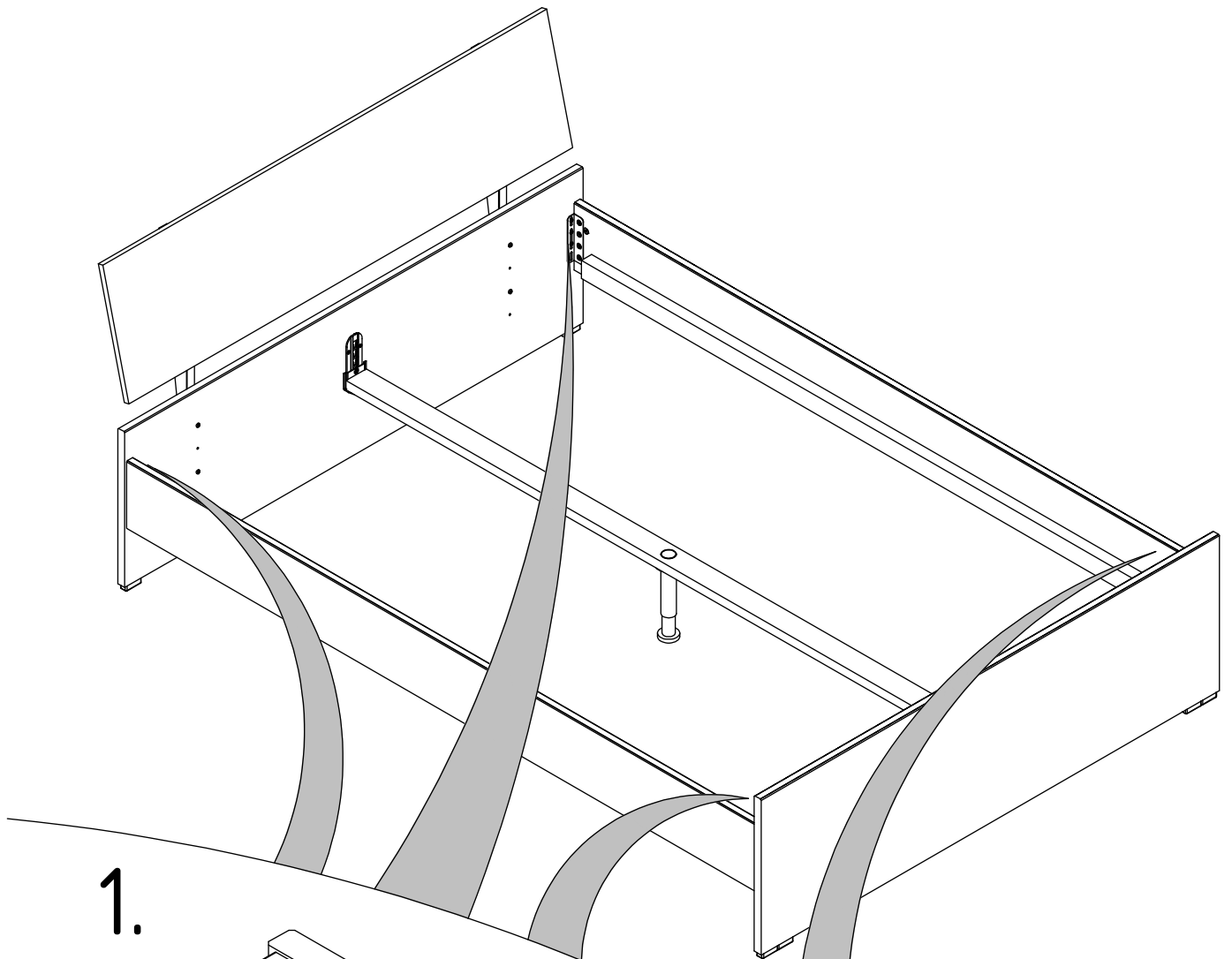

1.

4x

2.

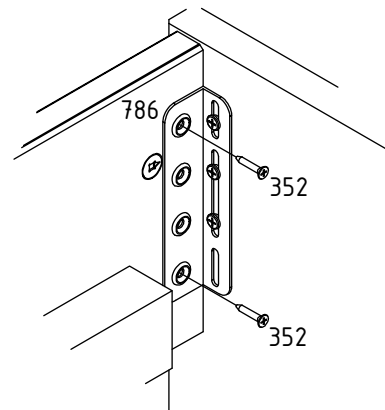
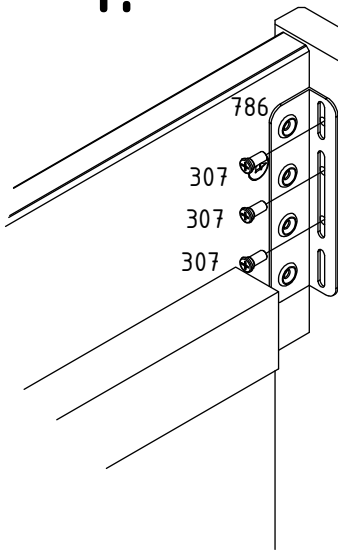

30

4x

